

T1

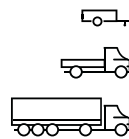

Trucks & Trailers

+ STANDARD PROFILES



TAKLER[®]
aluminium extrusion

“

Takler is a group of people who have always had a single territory of reference over time: the world.

Free people are those who are not afraid to try, to experiment, to dare.

They are people who have the courage to take risks and bring innovation to every field and beyond every border.

”

Lorenzo Lorusso
CEO



 Evolving has always been our way of being. It is the only way to fulfil our commitment: creating innovative solutions to be a step further for efficiency, quality and safety.

 Evolvere è il nostro percorso, da sempre. È l'unico modo per restare fedeli alla nostra missione: produrre soluzioni innovative, sempre un passo avanti per efficienza, qualità e sicurezza.

 Selbstentwicklung ist immer unser Weg. Es ist der einzige Weg, um unserer Verpflichtung nachzukommen: Innovative Lösungen zu schaffen, die einen Schritt weiter für Effizienz, Qualität und Sicherheit sind.

 Progresar es nuestro camino, desde siempre. Es la única manera de permanecer fieles a nuestra misión: producir soluciones innovadoras, siempre un paso adelante hacia eficacia, calidad y seguridad.

 Evoluer représente notre chemin depuis toujours. Il est le seul moyen d'être fidèle à notre mission : créer des solutions innovantes, qui soient toujours un pas en avant pour qualité, sécurité et efficacité.

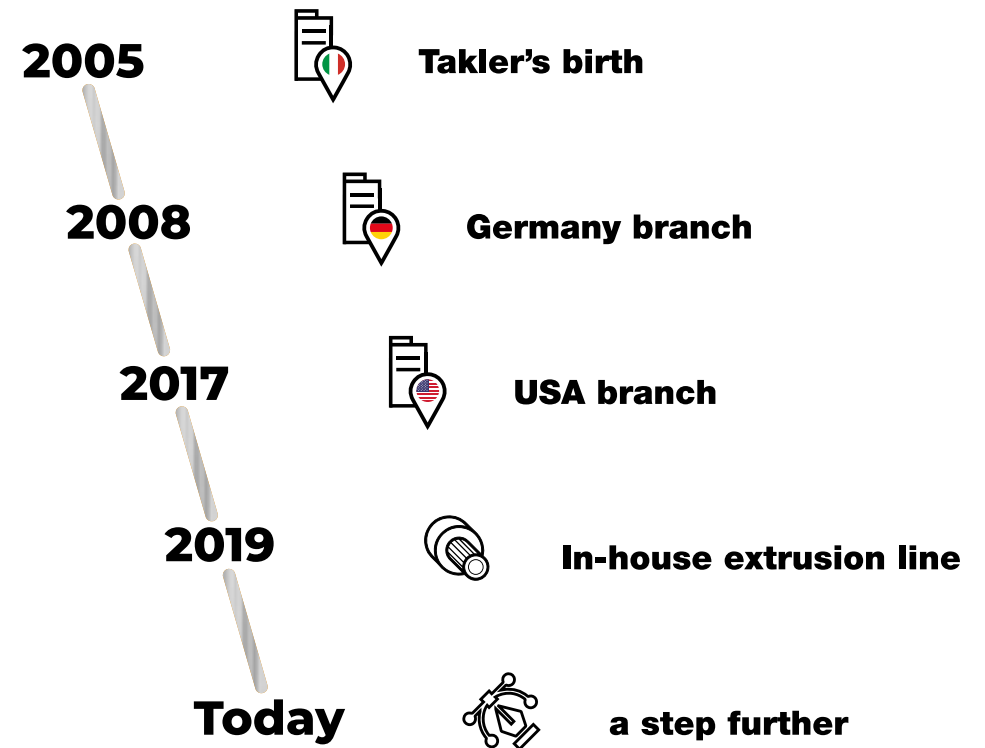

a step further

Index

Trucks & trailers profiles

page

01	Profili per sponde / Sideboard profiles	18
02	Profili per soprasponde / Side plank profiles	48
03	Profili testata / Cover profiles	52
04	Sponde monoprofilo / One-piece profiles	55
05	Sponde per ribaltabili / Tipper profiles	69
06	Profili per pianali / Loading platform profiles	81
07	Profili per isotermici / Refrigerated van profiles	83
00	Applicazioni varie / Miscellaneous	89

Roof profiles

page

01	Guide per tetto NS2/FIX / NS2/FIX Roof Guide Profiles	100
02	Guide per tetto Topline 2 / TOPLINE 2 Roof Guide Profiles	102
03	Guide per tetto Smart Style Topline 2/FIX20 / Smart Style Topline 2/FIX20 Roof Guide Profiles	104

Standard profiles

page







01	Angolari lati uguali / Angulars equal sides	108
02	Angolari lati disuguali / Angulars unequal sides	109
03	Profili ad "u" lati uguali / U profiles equal sides	110
04	Profili ad "u" lati disuguali / U profiles unequal sides	111
05	Tubi quadri / Square tubes	112
06	Tubi rettangolari / Rectangular tubes	114
07	Tubi tondi / Round tubes	116
08	Piatti / Plates	117



Aluminium profiles for trucks and trailers

01	PROFILI PER SPONDE <i>SIDEBOARD PROFILES</i>	18
02	PROFILI PER SOPRASPONDE <i>SIDE PLANK PROFILES</i>	48
03	PROFILI TESTATA <i>COVER PROFILES</i>	52
04	SPONDE MONOPROFILO <i>ONE-PIECE PROFILES</i>	55
05	SPONDE PER RIBALTABILI <i>TIPPER PROFILES</i>	69
06	PROFILI PER PIANALI <i>LOADING PLATFORM PROFILES</i>	81
07	PROFILI PER ISOTERMICI <i>REFRIGERATED VAN PROFILES</i>	83
00	APPLICAZIONI VARIE <i>MISCELLANEOUS</i>	89

DESCRIZIONE / DESCRIPTION	CODICE / PART NUMBER	PESO / WEIGHT kg/m	PROFILO / PROFILE	PAGINA / PAGE
01 PROFILI PER SPONDE / SIDEBORD PROFILES				
SUPERIORE H 100 mm UPPER H 100 mm	T1 1000	1,477		18
SUPERIORE H 150 mm UPPER H 150 mm	T1 1050	1,882		18
SUPERIORE RIBALTABILI H 195 mm UPPER FOR TIPPING SIDEBORDS H 195 mm	T1 1007	2,877		18
SUPERIORE H 200 mm UPPER H 200 mm	T1 1001	2,67		19
CENTRALE H 100 mm INTERMEDIATE H 100 mm	T1 1002	1,544		19
CENTRALE H 150 mm INTERMEDIATE H 150 mm	T1 1051	2,117		20
CENTRALE H 200 mm INTERMEDIATE H 200 mm	T1 1003	2,606		20
CENTRALE H 190 mm INTERMEDIATE H 190 mm	T1 1057	2,479		20
CENTRALE TIR H 150 mm INTERMEDIATE "TIR" H 150 mm	T1 1053	1,725		21
CENTRALE TIR H 200 mm INTERMEDIATE "TIR" H 200 mm	T1 1052	2,074		21
CENTRALE TIR H 200 mm INTERMEDIATE "TIR" H 200 mm	T1 1004	2,451		21
INFERIORE H 100 mm CON BATTUTA LOWER H 100 mm WITH WING	T1 1055	1,588		22
INFERIORE H 150 mm CON BATTUTA LOWER H 150 mm WITH WING	T1 1054	2,047		22
INFERIORE H 200 mm CON BATTUTA LOWER H 200 mm WITH WING	T1 1005	2,738		23
INFERIORE RIBALTABILI H 200 mm LOWER FOR TIPPING SIDEBORDS H 200 mm	T1 1008	2,654		23
INFERIORE RIBALTABILI H 200 mm LOWER FOR TIPPING SIDEBORDS H 200 mm	T1 1048	3,020		23
INFERIORE H 200 mm CON INCAVO PER GUARNIZIONE LOWER H 200 mm WITH SLOT FOR RUBBER GASKET	T1 1006	2,824		24
INFERIORE H 200 mm CON BATTUTA A ROVESCIO LOWER H 200 mm WITH REVERSED WING	T1 1056	2,605		24
INFERIORE CON CERNIERA H 100 mm LOWER WITH HINGE H 100 mm	T1 1049	3,33		25

DESCRIZIONE / DESCRIPTION	CODICE / PART NUMBER	PESO / WEIGHT kg/m	PROFILO / PROFILE	PAGINA / PAGE
INFERIORE H 200 mm CON CERNIERA LOWER H 200 mm WITH HINGE	T1 1023	4,523		25
SUPERIORE H 100 mm UPPER H 100 mm	T1 1026	1,361		26
SUPERIORE H 200 mm UPPER H 200 mm	T1 1009	2,257		26
CENTRALE H 100 mm INTERMEDIATE H 100 mm	T1 1010	1,299		26
CENTRALE H 200 mm INTERMEDIATE H 200 mm	T1 1011	2,317		27
CENTRALE TIR H 200 mm INTERMEDIATE "TIR" H 200 mm	T1 1012	2,462		27
CENTRALE TIR H 200 mm INTERMEDIATE "TIR" H 200 mm	T1 1027	2,360		28
CENTRALE TIR CON GANCIO H 200 mm INTERMEDIATE "TIR" WITH HOOK H 200 mm	T1 1028	2,565		28
INFERIORE H 200 mm CON BATTUTA LOWER H 200 mm WITH WING	T1 1013	2,557		29
INFERIORE H 200 mm CON BATTUTA A ROVESCIO LOWER H 200 mm WITH REVERSED WING	T1 1025	2,516		29
INFERIORE H 215 mm CON INCAVO PER GUARNIZIONE LOWER H 215 mm WITH SLOT FOR RUBBER GASKET	T1 1014	2,573		30
INFERIORE H 200 mm CON CERNIERA LOWER H 200 mm WITH HINGE	T1 1015	4,487		30
SUPERIORE PER RIBALTABILI H 195 mm UPPER FOR TIPPING SIDEBORDS H 195 mm	T1 1016	2,665		31
INFERIORE PER RIBALTABILI H 200 mm LOWER FOR TIPPING SIDEBORDS H 200 mm	T1 1017	2,689		31
SUPERIORE H 200 mm UPPER H 200 mm	T1 1018	2,373		32
CENTRALE PIENO H 100 mm INTERMEDIATE H 100 mm	T1 1019	1,422		32
CENTRALE PIENO H 200 mm INTERMEDIATE H 200 mm	T1 1020	2,441		33
CENTRALE TIR H 200 mm INTERMEDIATE "TIR" H 200 mm	T1 1021	2,176		33
INFERIORE H 200 mm CON BATTUTA LOWER H 200 mm WITH WING	T1 1022	2,653		34
INFERIORE H 200 mm CON INCAVO PER GUARNIZIONE LOWER H 200 mm WITH SLOT FOR RUBBER GASKET	T1 1024	2,560		34

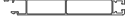
DESCRIZIONE / DESCRIPTION	CODICE / PART NUMBER	PESO / WEIGHT kg/m	PROFILO / PROFILE	PAGINA / PAGE
SUPERIORE H 100 mm UPPER H 100 mm	T1 1040	1,139		35
SUPERIORE H 150 mm UPPER H 150 mm	T1 1031	1,555		35
SUPERIORE H 200 mm UPPER H 200 mm	T1 1030	2,152		35
CENTRALE H 100 mm INTERMEDIATE H 100 mm	T1 1046	1,204		36
CENTRALE H 150 mm INTERMEDIATE H 150 mm	T1 1045	1,634		36
CENTRALE H 200 mm INTERMEDIATE H 200 mm	T1 1032	2,171		36
CENTRALE TIR H 150 mm INTERMEDIATE "TIR" H 150 mm	T1 1047	1,590		37
CENTRALE TIR H 200 mm INTERMEDIATE "TIR" H 200 mm	T1 1035	1,563		37
INFERIORE H 200 mm CON BATTUTA LOWER H 200 mm WITH WING	T1 1033	2,419		38
INFERIORE H 220 mm CON INCAVO PER GUARNIZIONE LOWER H 220 mm WITH SLOT FOR RUBBER GASKET	T1 1034	2,527		38
TERMINALE SUPERIORE H 200 mm UPPER TERMINAL H 200 mm	T1 1058	2,389		39
TERMINALE SUPERIORE H 150 mm UPPER TERMINAL H 150 mm	T1 1059	1,828		39
TERMINALE SUPERIORE H 100 mm UPPER TERMINAL H 100 mm	T1 1060	1,396		40
TERMINALE SUPERIORE H 50 mm UPPER TERMINAL H 50 mm	T1 1061	0,964		40
CENTRALE H 200 mm INTERMEDIATE H 200 mm	T1 1062	2,230		41
CENTRALE H 150 mm INTERMEDIATE H 150 mm	T1 1063	1,852		41
CENTRALE H 200 mm INTERMEDIATE H 200 mm	T1 1064	2,244		42
CENTRALE H 150 mm INTERMEDIATE H 150 mm	T 1065	1,803		42
CENTRALE H 100 mm INTERMEDIATE H 100 mm	T1 1066	1,371		43
TERMINALE INFERIORE H 200 mm LOWER TERMINAL H 200 mm	T1 1067	2,441		43





DESCRIZIONE / DESCRIPTION	CODICE / PART NUMBER	PESO / WEIGHT kg/m	PROFILO / PROFILE	PAGINA / PAGE
TERMINALE INFERIORE H 200 mm LOWER TERMINAL H 200 mm	T1 1068	2,562		44
TERMINALE INFERIORE H 100 mm LOWER TERMINAL H 100 mm	T1 1069	1,587		44
TERMINALE INFERIORE H 200 mm LOWER TERMINAL H 200 mm	T1 1070	2,562		45
TERMINALE INFERIORE H 200 mm LOWER TERMINAL H 200 mm	T1 1071	2,487		45
TERMINALE INFERIORE H 100 mm LOWER TERMINAL H 100 mm	T1 1072	1,509		46
TERMINALE INFERIORE H 200 mm LOWER TERMINAL H 200 mm	T1 1073	2,400		46
TERMINALE INFERIORE H 100 mm LOWER TERMINAL H 100 mm	T1 1074	1,264		47

02 PROFILI PER SOPRASPONDE / SIDE PLANK PROFILES



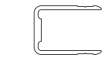
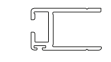

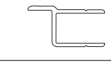







TUBOLARE 100 X 25 mm TUBULAR 100 X 25 mm	T1 2001	0,953		48
TUBOLARE 100 X 25 mm CON RINFORZO REINFORCED TUBULAR 100 X 25 mm	T1 2002	1,037		48
TUBOLARE 100 X 25 mm TIPO FRANCESE TUBULAR 100 X 25 mm	T1 2004	1,107		49
TUBOLARE 150 X 25 mm TIPO FRANCESE CON RINFORZO REINFORCED TUBULAR 150 X 25 mm	T1 2003	1,607		49
TUBOLARE 150 X 25 mm TIPO FRANCESE CON RINFORZO REINFORCED TUBULAR 150 X 25 mm	T1 2005	1,544		50
TUBOLARE 110 X 25 mm TIPO FRANCESE CON RINFORZO REINFORCED TUBULAR 110 X 25 mm	T1 2006	1,161		50
TUBOLARE 136 X 25 mm TIPO FRANCESE CON RINFORZO REINFORCED TUBULAR 136 X 25 mm	T1 2007	1,441		51
TUBOLARE 95 X 25 mm TIPO FRANCESE CON RINFORZO REINFORCED TUBULAR 95 X 25 mm	T1 2008	1,091		51

03 PROFILI TESTATA / COVER PROFILES



PROFILO TESTATA DRITTO RIGHT COVER PROFILE	T1 3000	1,345		52
PROFILO TESTATA TONDO ROUND COVER PROFILE	T1 3006	1,142		52
TESTATA 40 X 25,5 mm SENZA BATTUTA COVER PROFILE 40 X 25,5 mm w/o WING	T1 3001	0,756		53

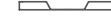
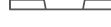

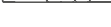
DESCRIZIONE / DESCRIPTION	CODICE / PART NUMBER	PESO / WEIGHT kg/m	PROFILO / PROFILE	PAGINA / PAGE
TESTATA SENZA BATTUTA / COVER PROFILE W/O WING 42 X 30,5 MM	T1 3007	0,760		53
TESTATA 50 X 25,5 mm c/INCAVO PER GUARNIZIONE COVER PROFILE 50X25,5 mm w/ SLOT FOR RUBBER GASKET	T1 3002	0,996		53
TESTATA 40/60 X 25,5 mm CON BATTUTA COVER PROFILE 40/60 x 25,5 mm w/WING	T1 3003	1,002		54
TESTATA 40,5/60,5 X 25,5 mm CON BATTUTA SPOSTATA COVER PROFILE 40,5/60,5 X 25,5 mm w/ DISPLACED WING	T1 3004	0,880		54
TESTATA DOPPIA 102 X 25,8 mm SENZA BATTUTA DOUBLE COVER PROFILE 102 X 25,8 mm w/o WING	T1 3005	2,136		54



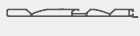





04 SPONDE MONOPROFILO / ONE-PIECE PROFILES





MONOPROFILO H 200 mm ONE-PIECE PROFILE H 200 mm	T1 4006	2,541		55
MONOPROFILO H 300 mm ONE-PIECE PROFILE H 300 mm	T1 4010	3,294		56
MONOPROFILO H 300 mm ONE-PIECE PROFILE H 300 mm	T1 4013	3,892		57
MONOPROFILO H 350 mm ONE-PIECE PROFILE H 350 mm	T1 4008	4,933		58
MONOPROFILO H 400 mm ONE-PIECE PROFILE H 400 mm	T1 4009	4,964		59
MONOPROFILO H 400 mm ONE-PIECE PROFILE H 400 mm	T1 4011	2,911		60
MONOPROFILO H 300 mm ONE-PIECE PROFILE H 300 mm	T1 4001	3,243		61
MONOPROFILO H 350 mm ONE-PIECE PROFILE H 350 mm	T1 4002	4,317		62
MONOPROFILO "SLIM" H 400 mm ONE-PIECE PROFILE "SLIM" H 400 mm	T1 4004	3,980		63
MONOPROFILO H 350 mm ONE-PIECE PROFILE H 350 mm	T1 4012	4,423		64
MONOPROFILO H 400 mm ONE-PIECE PROFILE H 300 mm	T1 4014	3,151		65
MONOPROFILO H 300 mm ONE-PIECE PROFILE H 300 mm	T1 4015	2,910		65
MONOPROFILO H 400 mm CON GANCIO H 157 mm ONE-PIECE PROFILE H 400 mm WITH HOOK H 157 mm	T1 4003	4,423		66
MONOPROFILO H 400 mm CON GANCIO H 174 mm ONE-PIECE PROFILE H 400 mm WITH HOOK H 174 mm	T1 4005	4,304		67
MONOPROFILO H 400 mm CON GANCIO ONE-PIECE PROFILE H 400 mm WITH HOOK	T14007	4,064		68

DESCRIZIONE / DESCRIPTION	CODICE / PART NUMBER	PESO / WEIGHT kg/m	PROFILO / PROFILE	PAGINA / PAGE
05 SPONDE PER RIBALTABILI / TIPPER PROFILES				
SUPERIORE "LIGHT" H 200 mm UPPER "LIGHT" H 200 mm	T1 5001	3,360		69
CENTRALE PIENO "LIGHT" H 100 mm INTERMEDIATE "LIGHT" H 100 mm	T1 5002	1,552		69
CENTRALE PIENO "LIGHT" H 200 mm INTERMEDIATE "LIGHT" H 200 mm	T1 5003	2,661		69
INFERIORE "LIGHT" H 200 mm CON BATTUTA LOWER "LIGHT" H 200 mm WITH WING	T1 5004	3,223		70
INFERIORE "LIGHT" H 200 mm CON CERNIERA LOWER "LIGHT" H 200 mm WITH HINGE	T1 5006	4,381		70
SUPERIORE "HEAVY" H 200 mm UPPER "HEAVY" H 200 mm	T1 9001	4,555		71
CENTRALE PIENO "HEAVY" H 100 mm INTERMEDIATE "HEAVY" H 100 mm	T1 9003	1,769		71
CENTRALE PIENO "HEAVY" H 200 mm INTERMEDIATE "HEAVY" H 200 mm	T1 9002	3,183		71
INFERIORE "HEAVY" H 200 mm CON BATTUTA LOWER "HEAVY" H 200 mm WITH WING	T1 9005	3,829		72
INFERIORE "HEAVY" H 200 mm CON CERNIERA LOWER "HEAVY" H 200 mm WITH HINGE	T1 9004	5,216		72
SUPERIORE H 150 mm UPPER H 150 mm	T1 1038	4,285		73
SUPERIORE H 200 mm UPPER H 200 mm	T1 1037	4,847		73
CENTRALE H 150 mm INTERMEDIATE H 150 mm	T1 1039	2,851		74
CENTRALE H 200 mm INTERMEDIATE H 200 mm	T1 1036	3,432		74
INFERIORE H 200 mm LOWER H 200 mm	T1 1042	3,799		75
INFERIORE H 200 mm CON BATTUTA LOWER H 200 mm WITH WING	T1 1043	3,853		75
INFERIORE H 200 mm CON CERNIERA LOWER H 200 mm WITH HINGE	T1 1041	5,273		76
TESTATA PER TR5 COVER PROFILE FOR TR5	T1 1044	1,758		76
MONOPROFILO H 400 mm ONE-PIECE PROFILE H 400 mm	T1 5005	5,513		77

DESCRIZIONE / DESCRIPTION	CODICE / PART NUMBER	PESO / WEIGHT kg/m	PROFILO / PROFILE	PAGINA / PAGE
05 SPONDE PER RIBALTABILI / TIPPER PROFILES				
MONOPROFILO H 400 mm ONE-PIECE PROFILE H 400 mm	T1 5007	7,695		78
MONOPROFILO H 400 MM CON GANCIO ONE-PIECE PROFILE H 400 MM WITH HOOK	T1 5008	4,258		79
MONOPROFILO TR5 H 400 MM ONE-PIECE PROFILE TR5 H 400 MM	T1 5009	6,791		80

06 PROFILI PER PIANALI / LOADING PLATFORM PROFILES				
PROFILO LONGHERINA L 64,8 mm X H 112 mm SIDE RAIL PROFILE W 64,8 mm X H 112 mm	T1 6004	1,758		81
PIANALE L 200 mm X H 30 mm PLATFORM W 200 mm X H 30 mm	T1 6001	3,648		82
PIANALE L 300 mm X H 40 mm PLATFORM W 300 mm X H 40 mm	T1 6003	6,907		82

07 PROFILI PER ISOTERMICI / REFRIGERATED VAN PROFILES				
PROFILO TETTO TONDO PER FURGONATURE ROUND ROOF PROFILE FOR VANS	T1 7000	1,990		83
PROFILO ANGOLARE PIATTO 60 X 40 mm FLAT ANGULAR PROFILE 60 X 40 mm	T1 7001	0,575		83
PROFILO ANGOLARE PIATTO 60 X 80 mm FLAT ANGULAR PROFILE 60 X 80 mm	T1 7002	0,832		83
PROFILO ANGOLARE CURVO 60 X 60 mm CURVED ANGULAR PROFILE 60 X 60 mm	T1 7004	0,759		84
PROFILO ANGOLARE CURVO 60 X 60 mm CURVED ANGULAR PROFILE 60 X 60 mm	T1 7013	0,712		84
PROFILO ANGOLARE CURVO 60 X 80 mm CURVED ANGULAR PROFILE 60 X 80 mm	T1 7003	0,855		84
PROFILO ANGOLARE CURVO 60 X 100 mm CURVED ANGULAR PROFILE 60 X 100 mm	T1 7009	0,891		85
PROFILO PIATTO RIGATO H 142 mm FLAT LINED PROFILE H 142 mm	T1 7005	1,153		85
PROFILO GUIDOVIA H 285 mm OVERHEAD RAIL PROFILE H 258 mm	T1 7010	2,169		86

DESCRIZIONE / DESCRIPTION	CODICE / PART NUMBER	PESO / WEIGHT kg/m	PROFILO / PROFILE	PAGINA / PAGE
PROFILO PIATTO RIGATO H 260 mm FLAT LINED PROFILE 260 mm	T1 7011	1,312		87
PROFILO PIATTO RIGATO H 285 mm FLAT LINED PROFILE H 285 mm	T1 7006	2,322		87
PROFILO A "L" RIGATO H 260 mm L LINED PROFILE 260 mm	T1 7012	1,604		88
PROFILO A "L" RIGATO H 285 mm "L" LINED PROFILE H 285 mm	T1 7008	2,651		88

00 APPLICAZIONI VARIE / MISCELLANEOUS				
PROFILO TENSIONATORE 88 x 28 mm STRETCHING PLANCK 88 x 28 mm	T1 8001	2,349		89
PROFILO TENSIONATORE 80 x 28 mm STRETCHING PLANCK 80 x 28 mm	T1 8003	2,165		89
PROFILO TENSIONATORE 84 x 25 mm STRETCHING PLANCK 84 x 25 mm	T1 8009	1,625		90
AGGANCIAMENTO TELO 61 x 20 mm TARPAULIN HOOK 61 x 20 mm	T1 8002	0,883		91
AGGANCIAMENTO TELO 55 x 21 mm TARPAULIN HOOK 55 x 21 mm	T1 8004	0,918		91
AGGANCIAMENTO TELO 70 x 18 mm TARPAULIN HOOK 70 x 18 mm	T1 8005	0,853		92
AGGANCIAMENTO TELO 60 X 20 mm TARPAULIN HOOK 60 X 20 mm	T1 8006	0,640		92
AVVOLGI TENDI TELONE 33 x 34 mm TARPAULIN TENSIONING POLE 33 x 34 mm	T1 8007	1,048		93
AVVOLGI TENDI TELONE 32,6 x 34 mm TARPAULIN TENSIONING POLE 32,6 x 34 mm	T1 8012	0,608		93
AVVOLGI TENDI TELONE 26,5 x 27 mm TARPAULIN TENSIONING POLE 26,5 x 27 mm	T1 8008	0,608		93
AVVOLGI TENDI TELONE HEAVY 25 x 25 mm HEAVY TARPAULIN TENSIONING POLE 25x25 mm	T1 8013	0,688		93
PROFILO TENSIONATORE 85 x 32 mm STRETCHING PLANCK 85 x 32 mm	T1 8010	2,141		94
PROFILO TENDI TELONE TENSIONING POLE PROFILE	T1 8011	0,211		94

01

PROFILI PER SPONDE SIDEBOARD PROFILES

Superiore / Upper
H 100 mm

TR1

CODICE /
PART NUMBER

T1 1000

PESO /
WEIGHT kg/m
1,477

LEGA / ALLOY
EN AW-6060

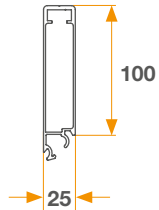

Superiore / Upper
H 150 mm

TR1

CODICE /
PART NUMBER

T1 1050

PESO /
WEIGHT kg/m
1,882

LEGA / ALLOY
EN AW-6060

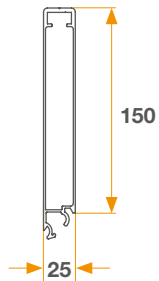

Superiore ribaltabili / Upper for tipping sideboards
H 195 mm

TR1

CODICE /
PART NUMBER

T1 1007

PESO /
WEIGHT kg/m
2,892

LEGA / ALLOY
EN AW-6060

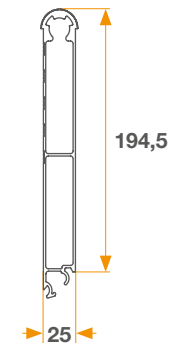

01 PROFILI PER SPONDE / SIDEBOARD PROFILES

Superiore / Upper
H 200 mm

TR1

CODICE /
PART NUMBER

T1 1001

PESO /
WEIGHT kg/m
2,670

LEGA / ALLOY
EN AW-6060

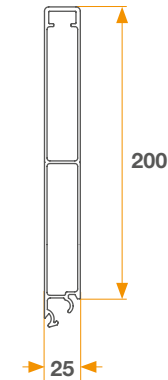

Centrale / Central
H 100 mm

TR1

CODICE /
PART NUMBER

T1 1002

PESO /
WEIGHT kg/m
1,544

LEGA / ALLOY
EN AW-6060

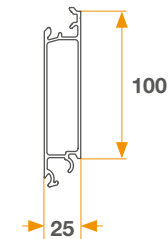

01 PROFILI PER SPONDE / SIDEBORD PROFILES

Centrale / Intermediate
H 150mm

TR1
CODICE /
PART NUMBER
T1 1051
PESO /
WEIGHT kg/m
2,117
LEGA / ALLOY
EN AW-6060

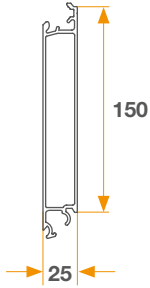

01 PROFILI PER SPONDE / SIDEBORD PROFILES

Centrale tir / Intermediate "tir"
H 150 mm

TR1
CODICE /
PART NUMBER
T1 1053
PESO /
WEIGHT kg/m
1,725
LEGA / ALLOY
EN AW-6060

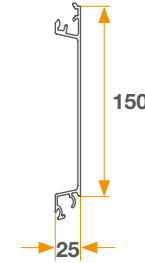

Centrale / Intermediate
H 200 mm

TR1
CODICE /
PART NUMBER
T1 1003
PESO /
WEIGHT kg/m
2,606
LEGA / ALLOY
EN AW-6060

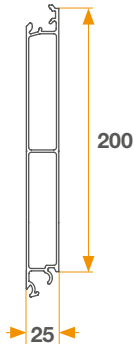

Centrale tir / Intermediate "tir"
H 200 mm

TR1
CODICE /
PART NUMBER
T1 1052
PESO /
WEIGHT kg/m
2,074
LEGA / ALLOY
EN AW-6060

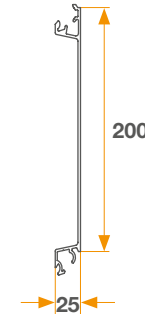

Centrale / Intermediate
H 190 mm

TR1
CODICE /
PART NUMBER
T1 1057
PESO /
WEIGHT kg/m
2,479
LEGA / ALLOY
EN AW-6060

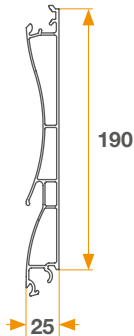

Centrale tir / Intermediate "tir" H 200 mm

TR1
CODICE /
PART NUMBER
T1 1004
PESO /
WEIGHT kg/m
2,451
LEGA / ALLOY
EN AW-6060

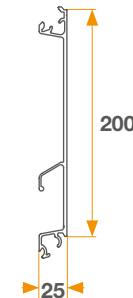

01 PROFILI PER SPONDE / SIDEBORD PROFILES

Inferiore con battuta / Lower with wing
H 100 mm

TR1
CODICE /
PART NUMBER
T1 1055
PESO /
WEIGHT kg/m
1,588
LEGA / ALLOY
EN AW-6060

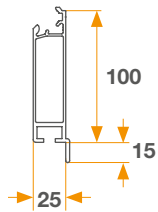

Inferiore con battuta / Lower with wing
H 150 mm

TR1
CODICE /
PART NUMBER
T1 1054
PESO /
WEIGHT kg/m
2,047
LEGA / ALLOY
EN AW-6060

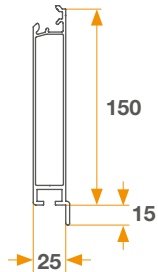

Inferiore con battuta / Lower with wing
H 200 mm

TR1
CODICE /
PART NUMBER
T1 1005
PESO /
WEIGHT kg/m
2,738
LEGA / ALLOY
EN AW-6060

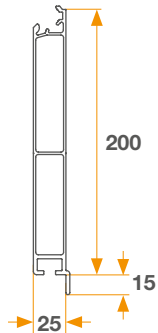

01 PROFILI PER SPONDE / SIDEBORD PROFILES

Inferiore ribaltabili / Lower for tipping sideboards
H 200 mm

TR1
CODICE /
PART NUMBER
T1 1008
PESO /
WEIGHT kg/m
2,654
LEGA / ALLOY
EN AW-6060

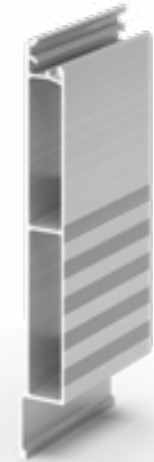
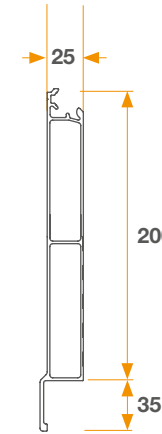

Inferiore ribaltabili / Lower for tipping sideboards
H 200 mm

TR1
CODICE /
PART NUMBER
T1 1048
PESO /
WEIGHT kg/m
3,02
LEGA / ALLOY
EN AW-6060

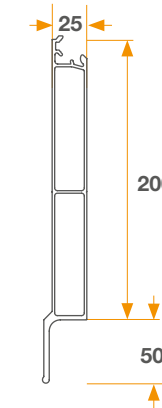

01 PROFILI PER SPONDE / SIDEBORD PROFILES

Inferiore con incavo per guarnizione / Lower with slot for rubber gasket
H 200 mm

TR1

CODICE /
PART NUMBER
T1 1006

PESO /
WEIGHT kg/m
2,824

LEGA / ALLOY
EN AW-6060

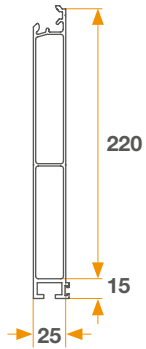

Inferiore con battuta a rovescio / Lower with reversed wing
H 200 mm

TR1

CODICE /
PART NUMBER
T1 1056

PESO /
WEIGHT kg/m
2,605

LEGA / ALLOY
EN AW-6060

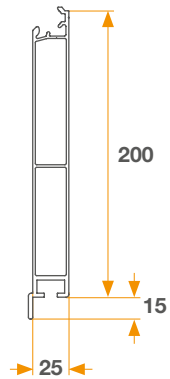

01 PROFILI PER SPONDE / SIDEBORD PROFILES

Inferiore con cerniera / Lower with hinge
H 100 mm

TR1

CODICE /
PART NUMBER
T1 1049

PESO /
WEIGHT kg/m
3,33

LEGA / ALLOY
EN AW-6060

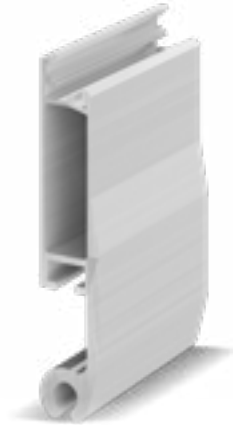
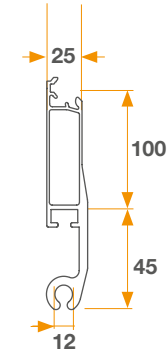

Inferiore con cerniera / Lower with hinge
H 200 mm

TR1

CODICE /
PART NUMBER
T1 1023

PESO /
WEIGHT kg/m
4,523

LEGA / ALLOY
EN AW-6060

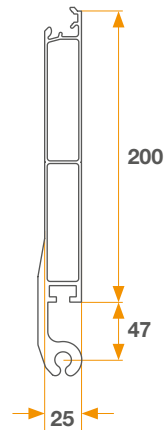

01 PROFILI PER SPONDE / SIDEBORD PROFILES

Superiore / Upper
H 100 mm

TS
CODICE /
PART NUMBER

T1 1026

PESO /
WEIGHT kg/m
1,361

LEGA / ALLOY
EN AW-6060

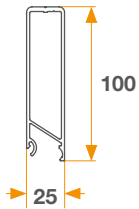

Superiore / Upper
H 200 mm

TS
CODICE /
PART NUMBER

T1 1009

PESO /
WEIGHT kg/m
2,257

LEGA / ALLOY
EN AW-6060

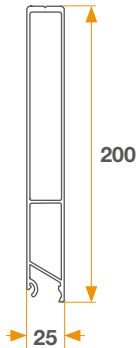

Centrale / Intermediate
H 100 mm

TS
CODICE /
PART NUMBER

T1 1010

PESO /
WEIGHT kg/m
1,299

LEGA / ALLOY
EN AW-6060

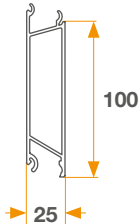

01 PROFILI PER SPONDE / SIDEBORD PROFILES

Centrale / Intermediate
H 200 mm

TS

CODICE /
PART NUMBER
T1 1011

PESO /
WEIGHT kg/m
2,317

LEGA / ALLOY
EN AW-6060

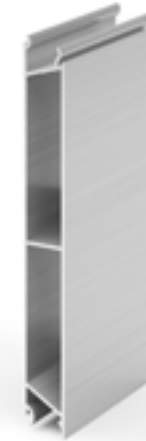
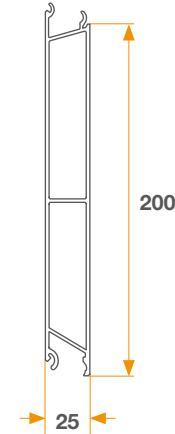

Centrale tir / Intermediate "tir"
H 200 mm

TS

CODICE /
PART NUMBER
T1 1012

PESO /
WEIGHT kg/m
2,462

LEGA / ALLOY
EN AW-6060

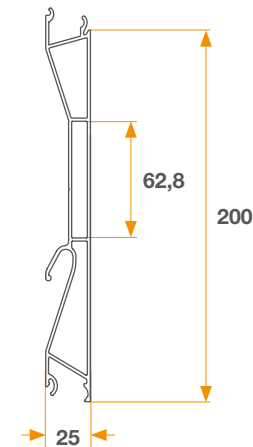

01 PROFILI PER SPONDE / SIDEBORD PROFILES

Centrale "tir" / Intermediate "tir"
H 200 mm

TS

**CODICE /
PART NUMBER**
T1 1027

**PESO /
WEIGHT** kg/m
2,360

LEGA / ALLOY
EN AW-6060

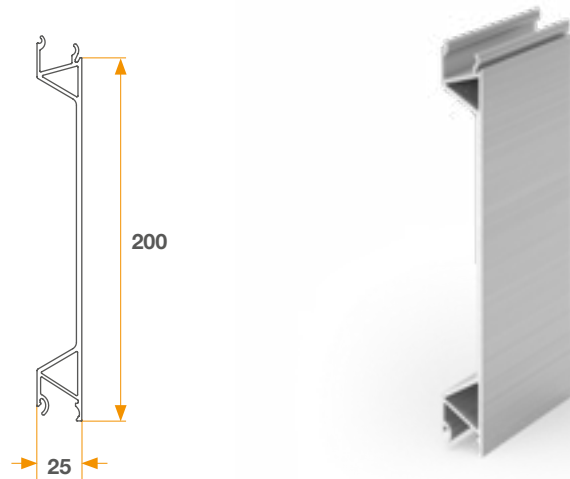

01 PROFILI PER SPONDE / SIDEBORD PROFILES

Inferiore con battuta / Lower with wing
H 200 mm

TS

**CODICE /
PART NUMBER**
T1 1013

**PESO /
WEIGHT** kg/m
2,557

LEGA / ALLOY
EN AW-6060

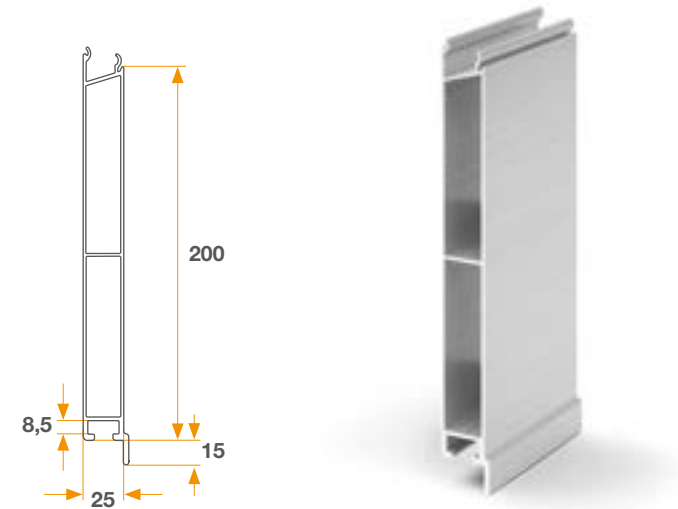

Centrale "tir" con gancio / Intermediate "tir" with hook
H 200 mm

TS

**CODICE /
PART NUMBER**
T1 1028

**PESO /
WEIGHT** kg/m
2,565

LEGA / ALLOY
EN AW-6060

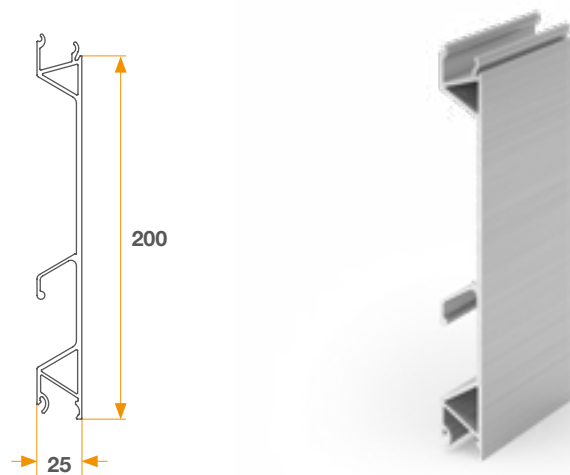

Inferiore con battuta a rovescio / Lower with reversed wing
H 200 mm

TS

**CODICE /
PART NUMBER**
T1 1025

**PESO /
WEIGHT** kg/m
2,516

LEGA / ALLOY
EN AW-6060

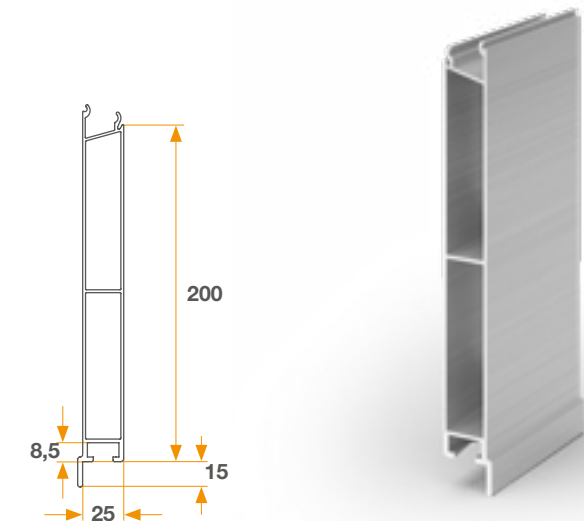

01 PROFILI PER SPONDE / SIDEBORD PROFILES

Inferiore con incavo per guarnizione / Lower with slot for rubber gasket
H 215 mm

TS

**CODICE /
PART NUMBER**
T1 1014

**PESO /
WEIGHT** kg/m
2,573

LEGA / ALLOY
EN AW-6060

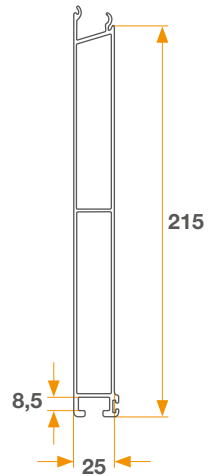

01 PROFILI PER SPONDE / SIDEBORD PROFILES

Superiore per ribaltabili / Upper for tipping sideboards
H 195 mm

TS

**CODICE /
PART NUMBER**
T1 1016

**PESO /
WEIGHT** kg/m
2,665

LEGA / ALLOY
EN AW-6060

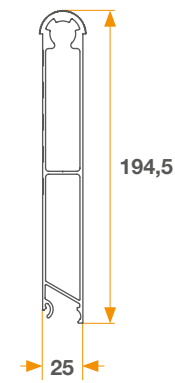

Inferiore con cerniera / Lower with hinge
H 200 mm

TS

**CODICE /
PART NUMBER**
T1 1015

**PESO /
WEIGHT** kg/m
4,487

LEGA / ALLOY
EN AW-6060

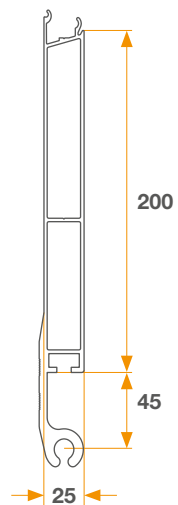

Inferiore per ribaltabili / Lower for tipping sideboards
H 200 mm

TS

**CODICE /
PART NUMBER**
T1 1017

**PESO /
WEIGHT** kg/m
2,689

LEGA / ALLOY
EN AW-6060

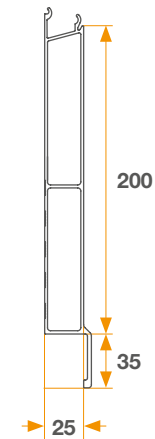

01 PROFILI PER SPONDE / SIDEBORD PROFILES

Superiore / Upper
H 200 mm

TR6

CODICE /
PART NUMBER
T1 1018

PESO /
WEIGHT kg/m
2,373

LEGA / ALLOY
EN AW-6060

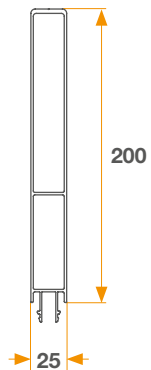

01 PROFILI PER SPONDE / SIDEBORD PROFILES

Centrale pieno / Intermediate
H 200 mm

TR6

CODICE /
PART NUMBER
T1 1020

PESO /
WEIGHT kg/m
2,441

LEGA / ALLOY
EN AW-6060

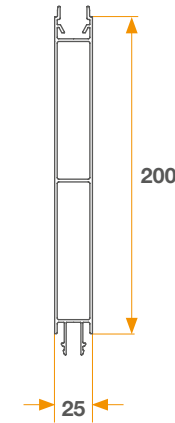

Centrale pieno / Intermediate
H 100 mm

TR6

CODICE /
PART NUMBER
T1 1019

PESO /
WEIGHT kg/m
1,422

LEGA / ALLOY
EN AW-6060

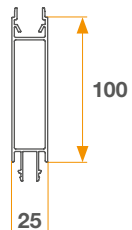

Centrale "tir" / Intermediate "tir"
H 200 mm

TR6

CODICE /
PART NUMBER
T1 1021

PESO /
WEIGHT kg/m
2,176

LEGA / ALLOY
EN AW-6060

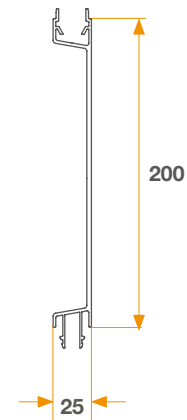

01 PROFILI PER SPONDE / SIDEBORD PROFILES

Inferiore con battuta / Lower with wing
H 200 mm

TR6

**CODICE /
PART NUMBER**
T1 1022

**PESO /
WEIGHT** kg/m
2,653

LEGA / ALLOY
EN AW-6060

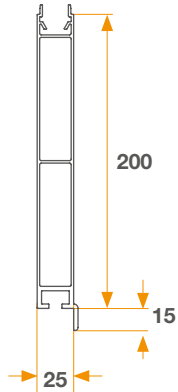

Inferiore con incavo per guarnizione /
Lower with slot for rubber gasket
H 220 mm

TR6

**CODICE /
PART NUMBER**
T1 1024

**PESO /
WEIGHT** kg/m
2,560

LEGA / ALLOY
EN AW-6060

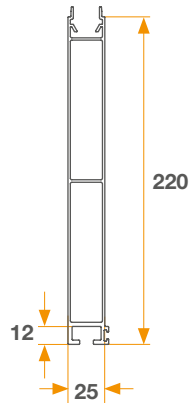

01 PROFILI PER SPONDE / SIDEBORD PROFILES

Superiore / Upper
H 100 mm

Alucar

**CODICE /
PART NUMBER**
T1 1040

**PESO /
WEIGHT** kg/m
1,139

LEGA / ALLOY
EN AW-6060

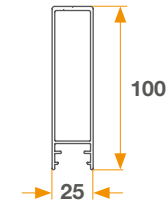

Superiore / Upper
H 150 mm

Alucar

**CODICE /
PART NUMBER**
T1 1031

**PESO /
WEIGHT** kg/m
1,555

LEGA / ALLOY
EN AW-6060

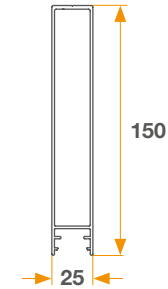

Superiore / Upper
H 200 mm

Alucar

**CODICE /
PART NUMBER**
T1 1030

**PESO /
WEIGHT** kg/m
2,152

LEGA / ALLOY
EN AW-6060

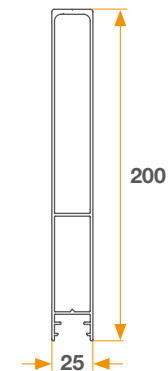

01 PROFILI PER SPONDE / SIDEBORD PROFILES

Centrale / Intermediate
H 100 mm

Alucar

CODICE /
PART NUMBER

T1 1046

PESO /
WEIGHT kg/m
1,204

LEGA / ALLOY
EN AW-6060

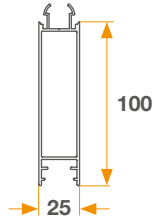

Centrale / Intermediate
H 150 mm

Alucar

CODICE /
PART NUMBER

T1 1045

PESO /
WEIGHT kg/m
1,634

LEGA / ALLOY
EN AW-6060

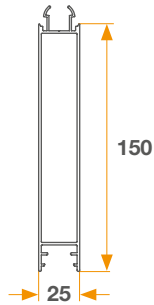

Centrale / Intermediate
H 200 mm

Alucar

CODICE /
PART NUMBER

T1 1032

PESO /
WEIGHT kg/m
2,171

LEGA / ALLOY
EN AW-6060

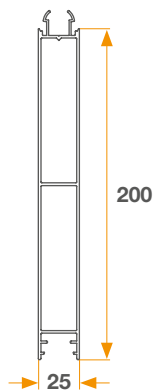

01 PROFILI PER SPONDE / SIDEBORD PROFILES

Centrale "tir" / Intermediate "tir"
H 150 mm

Alucar

CODICE /
PART NUMBER

T1 1047

PESO /
WEIGHT kg/m
1,590

LEGA / ALLOY
EN AW-6060

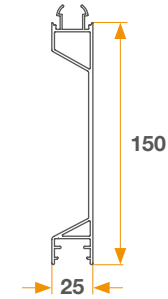

Centrale "tir" / Intermediate "tir"
H 200 mm

Alucar

CODICE /
PART NUMBER

T1 1035

PESO /
WEIGHT kg/m
1,563

LEGA / ALLOY
EN AW-6060

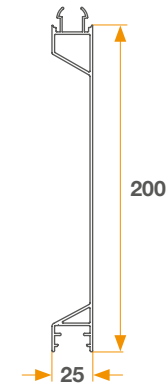

01 PROFILI PER SPONDE / SIDEBORD PROFILES

Inferiore con battuta / Lower with wing
H 200 mm

Alucar

CODICE /
PART NUMBER

T1 1033

PESO /
WEIGHT kg/m
2,419

LEGA / ALLOY
EN AW-6060

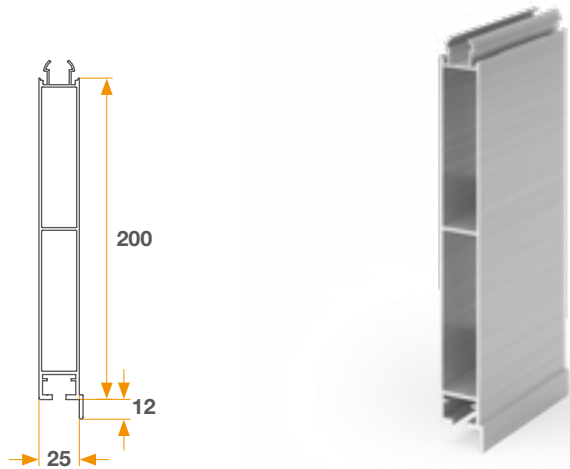

01 PROFILI PER SPONDE / SIDEBORD PROFILES

Terminale superiore / Upper terminal
H 200 mm

Snap lock

CODICE /
PART NUMBER

T1 1058

PESO /
WEIGHT kg/m
2,389

LEGA / ALLOY
EN AW-6063

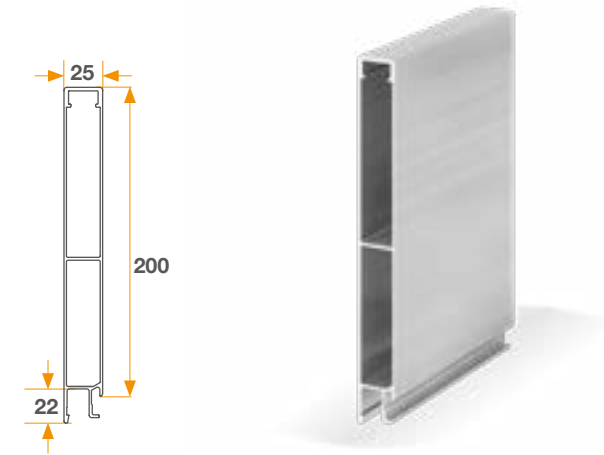

Inferiore con incavo per guarnizione / Lower with slot for rubber gasket
H 220 mm

Alucar

CODICE /
PART NUMBER

T1 1034

PESO /
WEIGHT kg/m
2,527

LEGA / ALLOY
EN AW-6060

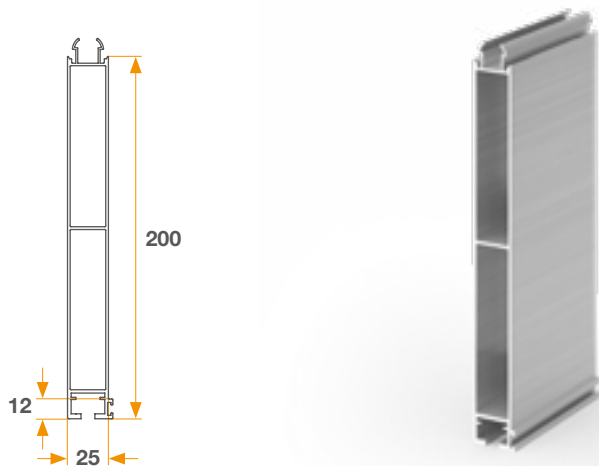

Terminale superiore / Upper terminal
H 150 mm

Snap lock

CODICE /
PART NUMBER

T1 1059

PESO /
WEIGHT kg/m
1,828

LEGA / ALLOY
EN AW-6063

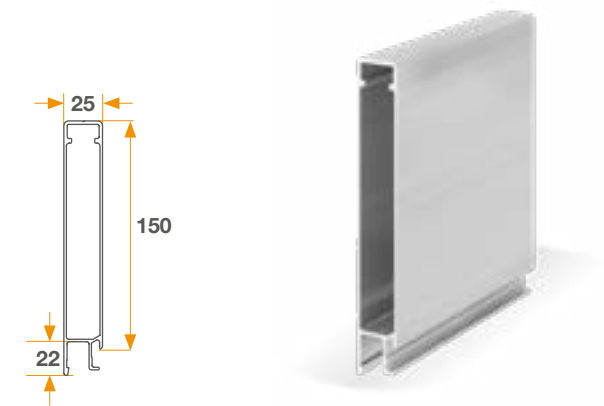

01 PROFILI PER SPONDE / SIDEBORD PROFILES

Terminale superiore / Upper terminal
H 100 mm

Snap lock

CODICE /
PART NUMBER

T1 1060

PESO /
WEIGHT kg/m
1,396

LEGA / ALLOY
EN AW-6063

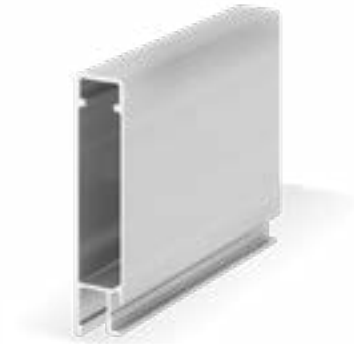
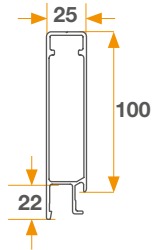

01 PROFILI PER SPONDE / SIDEBORD PROFILES

Centrale / Intermediate
H 200 mm

Snap lock

CODICE /
PART NUMBER

T1 1062

PESO /
WEIGHT kg/m
2,230

LEGA / ALLOY
EN AW-6063

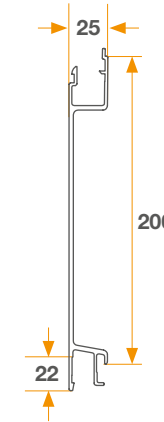

Terminale superiore / Upper terminal
H 50 mm

Snap lock

CODICE /
PART NUMBER

T1 1061

PESO /
WEIGHT kg/m
0,964

LEGA / ALLOY
EN AW-6063

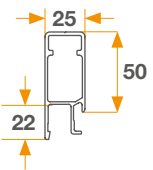

Centrale / Intermediate
H 150 mm

Snap lock

CODICE /
PART NUMBER

T1 1063

PESO /
WEIGHT kg/m
1,852

LEGA / ALLOY
EN AW-6063

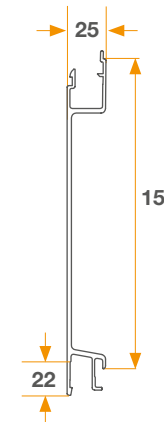

01 PROFILI PER SPONDE / SIDEBORD PROFILES

Centrale / Intermediate
H 200 mm

Snap lock

CODICE /
PART NUMBER

T1 1064

PESO /
WEIGHT kg/m
2,244

LEGA / ALLOY
EN AW-6063

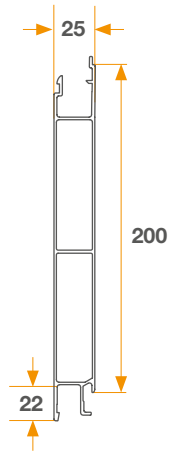

01 PROFILI PER SPONDE / SIDEBORD PROFILES

Centrale / Intermediate
H 100 mm

Snap lock

CODICE /
PART NUMBER

T1 1066

PESO /
WEIGHT kg/m
1,371

LEGA / ALLOY
EN AW-6063

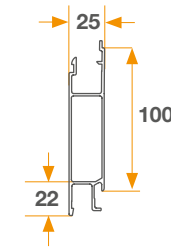

Centrale / Intermediate
H 150 mm

Snap lock

CODICE /
PART NUMBER

T1 1065

PESO /
WEIGHT kg/m
1,803

LEGA / ALLOY
EN AW-6063

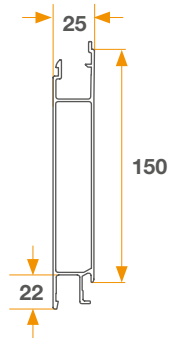

Terminale inferiore / Lower terminal
H 200 mm

Snap lock

CODICE /
PART NUMBER

T1 1067

PESO /
WEIGHT kg/m
2,441

LEGA / ALLOY
EN AW-6063

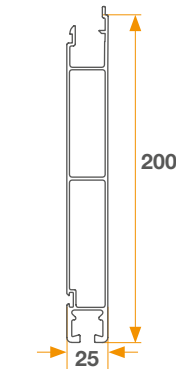

01 PROFILI PER SPONDE / SIDEBORD PROFILES

Terminale inferiore / Lower terminal
H 200 mm

Snap lock

CODICE /
PART NUMBER

T1 1068

PESO /
WEIGHT kg/m
2,562

LEGA / ALLOY
EN AW-6063

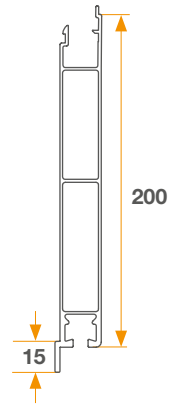

01 PROFILI PER SPONDE / SIDEBORD PROFILES

Terminale inferiore / Lower terminal
H 200 mm

Snap lock

CODICE /
PART NUMBER

T1 1070

PESO /
WEIGHT kg/m
2,562

LEGA / ALLOY
EN AW-6063

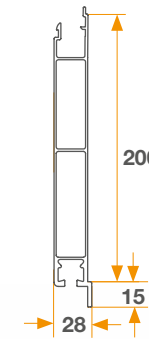

Terminale inferiore / Lower terminal
H 100 mm

Snap lock

CODICE /
PART NUMBER

T1 1069

PESO /
WEIGHT kg/m
1,587

LEGA / ALLOY
EN AW-6063

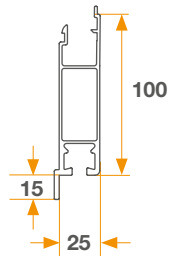

Terminale inferiore / Lower terminal
H 200 mm

Snap lock

CODICE /
PART NUMBER

T1 1071

PESO /
WEIGHT kg/m
2,487

LEGA / ALLOY
EN AW-6063

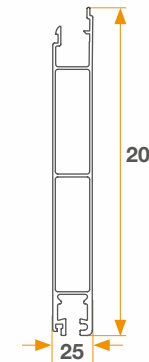

01 PROFILI PER SPONDE / SIDEBORD PROFILES

Terminale inferiore / Lower terminal
H 100 mm

Snap lock

CODICE /
PART NUMBER

T1 1072

PESO /
WEIGHT kg/m
1,509

LEGA / ALLOY
EN AW-6063

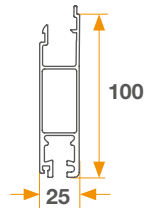

01 PROFILI PER SPONDE / SIDEBORD PROFILES

Terminale inferiore / Lower terminal
H 100 mm

Snap lock

CODICE /
PART NUMBER

T1 1074

PESO /
WEIGHT kg/m
1,264

LEGA / ALLOY
EN AW-6063

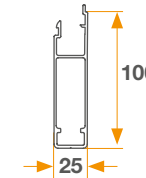

Terminale inferiore / Lower terminal
H 200 mm

Snap lock

CODICE /
PART NUMBER

T1 1073

PESO /
WEIGHT kg/m
2,400

LEGA / ALLOY
EN AW-6063

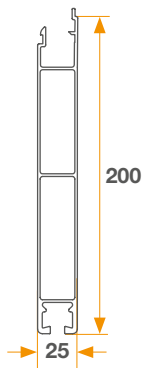

02

PROFILI PER SOPRASPONDE SIDE PLANK PROFILES

Tubolare / Tubular
100 x 25 mm

**CODICE /
PART NUMBER**

T1 2001

**PESO /
WEIGHT** kg/m
0,953

LEGA / ALLOY
EN AW-6060

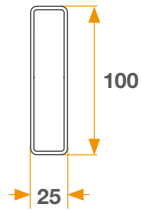

Tubolare con rinforzo / Reinforced tubular
100 x 25 mm

**CODICE /
PART NUMBER**

T1 2002

**PESO /
WEIGHT** kg/m
1,037

LEGA / ALLOY
EN AW-6060

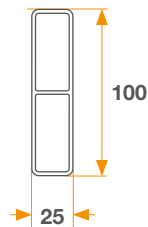

02 PROFILI PER SOPRASPONDE / SIDE PLANK PROFILES

Tubolare tipo francese / Tubular
100 x 25 mm

**CODICE /
PART NUMBER**

T1 2004

**PESO /
WEIGHT** kg/m
1,107

LEGA / ALLOY
EN AW-6060

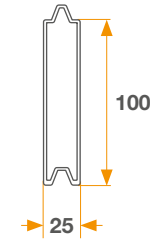

Tubolare tipo francese con rinforzo / Reinforced tubular
150 x 25 mm

**CODICE /
PART NUMBER**

T1 2003

**PESO /
WEIGHT** kg/m
1,607

LEGA / ALLOY
EN AW-6060

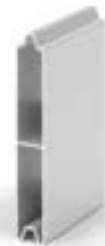
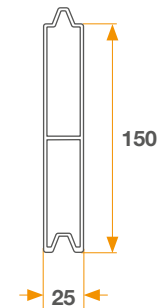

02 PROFILI PER SOPRASPONDE / SIDE PLANK PROFILES

Tubolare tipo francese con rinforzo / Reinforced tubular
150 x 25 mm

CODICE /
PART NUMBER

T1 2005

PESO /

WEIGHT kg/m

1,544

LEGA / ALLOY

EN AW-6060

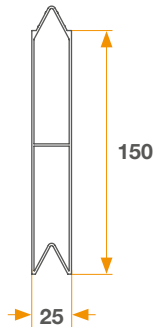

Tubolare tipo francese con rinforzo / Reinforced tubular
110 x 25 mm

CODICE /
PART NUMBER

T1 2006

PESO /

WEIGHT kg/m

1,161

LEGA / ALLOY

EN AW-6060

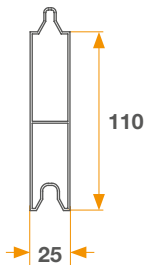

02 PROFILI PER SOPRASPONDE / SIDE PLANK PROFILES

Tubolare tipo francese con rinforzo / Reinforced tubular
136 x 25 mm

CODICE /
PART NUMBER

T1 2007

PESO /

WEIGHT kg/m

1,441

LEGA / ALLOY

EN AW-6060

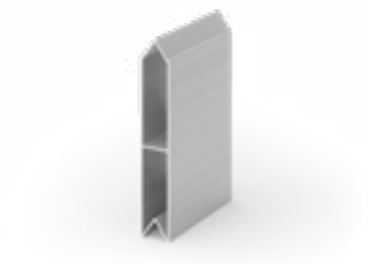
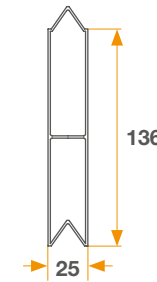

Tubolare tipo francese con rinforzo / Reinforced tubular
95 x 25 mm

CODICE /
PART NUMBER

T1 2008

PESO /

WEIGHT kg/m

1,091

LEGA /

EN AW-6060

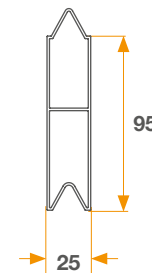

03 PROFILI TESTATA COVER PROFILES

Profilo testata dritto / Right cover profile

**CODICE /
PART NUMBER**

T1 3000

**PESO /
WEIGHT** kg/m
1,345

LEGA / ALLOY
EN AW-6060

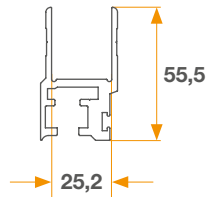

Profilo testata tondo / Round cover profile

**CODICE /
PART NUMBER**

T1 3006

**PESO /
WEIGHT** kg/m
1,142

LEGA / ALLOY
EN AW-6060

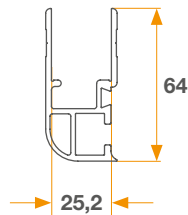

03 PROFILI TESTATA / COVER PROFILES

Testata senza battuta / Cover profile w/o wing
40 x 25,5 mm

**CODICE /
PART NUMBER**

T1 3001

**PESO /
WEIGHT** kg/m
0,756

LEGA / ALLOY
EN AW-6060

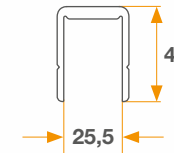

Testata senza battuta / Cover profile w/o wing
42 x 30,5 mm

**CODICE /
PART NUMBER**

T1 3007

**PESO /
WEIGHT** kg/m
0,760

LEGA / ALLOY
EN AW-6060

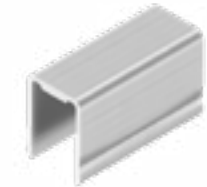
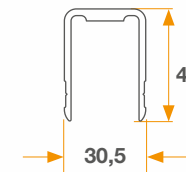

Testata c/incavo per guarnizione / Cover profile w/slot for rubber gasket
50 x 25,5 mm

**CODICE /
PART NUMBER**

T1 3002

**PESO /
WEIGHT** kg/m
0,996

LEGA / ALLOY
EN AW-6060

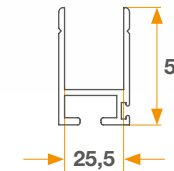

03 PROFILI TESTATA / COVER PROFILES

Testata con battuta / Cover profile w/wing
40/60 x 25,5 mm

**CODICE /
PART NUMBER**

T1 3003

**PESO /
WEIGHT** kg/m
1,002

LEGA / ALLOY
EN AW-6060

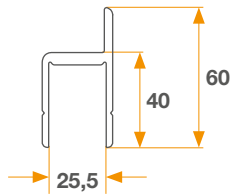

Testata con battuta spostata / Cover profile w/displaced wing
40/60 x 25,5 mm

**CODICE /
PART NUMBER**

T1 3004

**PESO /
WEIGHT** kg/m
0,880

LEGA / ALLOY
EN AW-6060

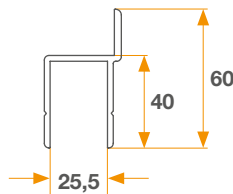

Testata doppia senza battuta / Double cover profile w/o wing
102 x 25,8 mm

**CODICE /
PART NUMBER**

T1 3005

**PESO /
WEIGHT** kg/m
2,136

LEGA / ALLOY
EN AW-6060

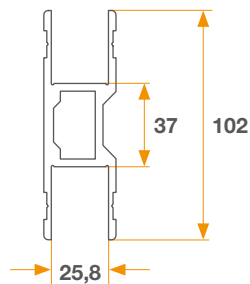

04 SPONDE MONOPROFILO ONE-PIECE PROFILES

Monoprofilo / One-piece profile
H 200 mm

**CODICE /
PART NUMBER**

T1 4006

**PESO /
WEIGHT** kg/m
2,541

LEGA / ALLOY
EN AW-6060

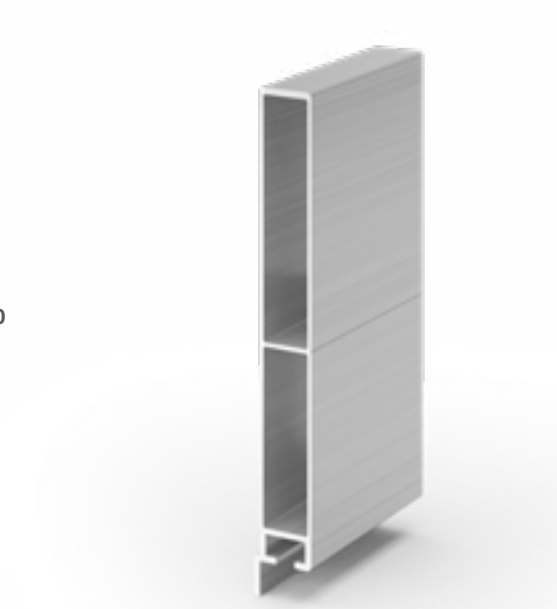
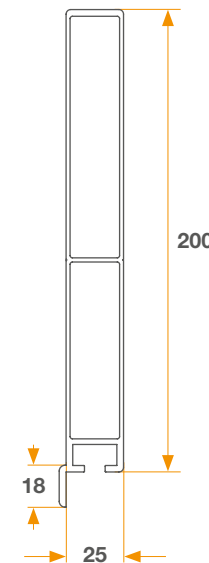

04 SPONDE MONOPROFILO / ONE-PIECE PROFILES

Monoprofilo / One-piece profile
H 300 mm

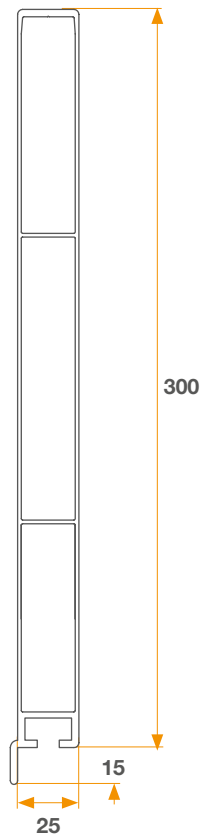

**CODICE /
PART NUMBER**
T1 4010

**PESO /
WEIGHT** kg/m
3,294

LEGA / ALLOY
EN AW-6060



04 SPONDE MONOPROFILO / ONE-PIECE PROFILES

Monoprofilo / One-piece profile
H 300 mm

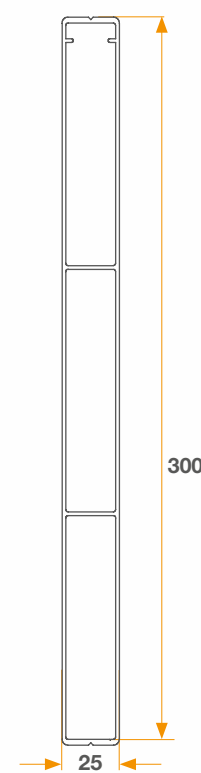

**CODICE /
PART NUMBER**
T1 4013

**PESO /
WEIGHT** kg/m
3,063

LEGA / ALLOY
EN AW-6060



04 SPONDE MONOPROFILO / ONE-PIECE PROFILES

Monoprofilo / One-piece profile
H 350 mm

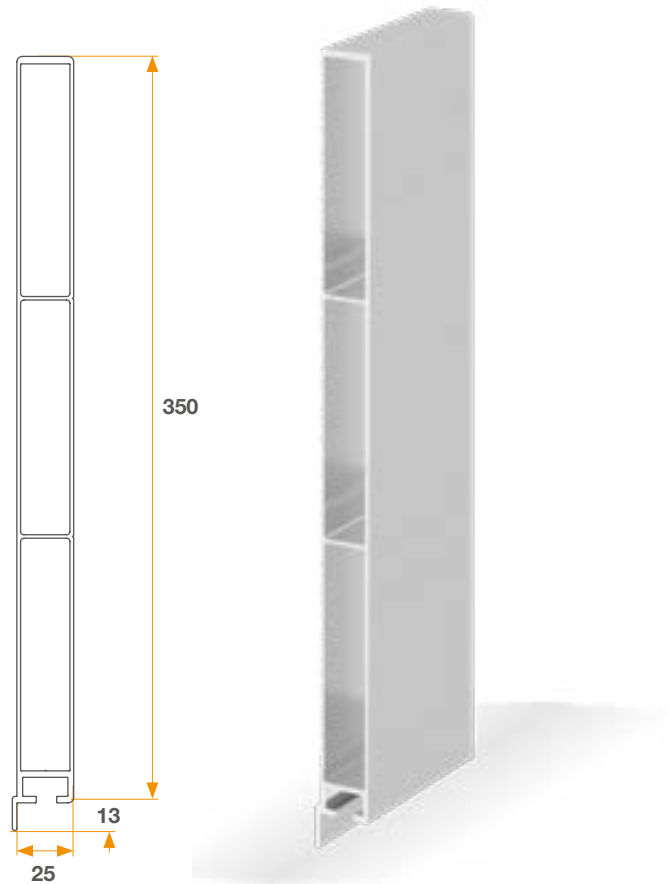

**CODICE /
PART NUMBER**
T1 4008

**PESO /
WEIGHT** kg/m
3,892

LEGA / ALLOY
EN AW-6060

04 SPONDE MONOPROFILO / ONE-PIECE PROFILES

Monoprofilo / One-piece profile
H 400 mm



**CODICE /
PART NUMBER**
T1 4009

**PESO /
WEIGHT** kg/m
4,933

LEGA / ALLOY
EN AW-6060

04 SPONDE MONOPROFILO / ONE-PIECE PROFILES

Monoprofilo / One-piece profile
H 400 mm

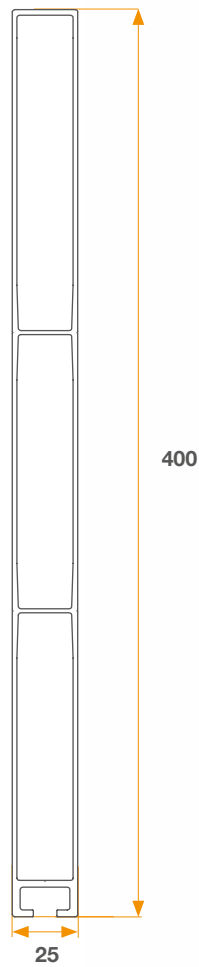

**CODICE /
PART NUMBER**
T1 4011

**PESO /
WEIGHT** kg/m
4,064

LEGA / ALLOY
EN AW-6060

04 SPONDE MONOPROFILO / ONE-PIECE PROFILES

Monoprofilo / One-piece profile
H 300 mm

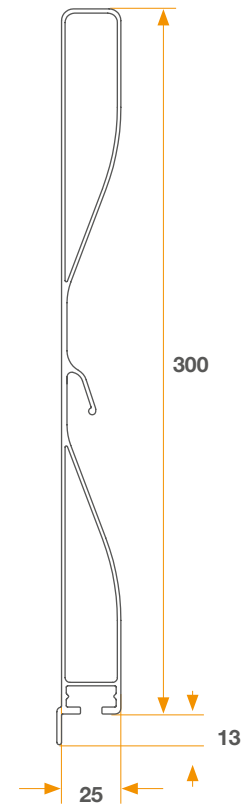

**CODICE /
PART NUMBER**
T1 4001

**PESO /
WEIGHT** kg/m
2,911

LEGA / ALLOY
EN AW-6060

04 SPONDE MONOPROFILO / ONE-PIECE PROFILES

Monoprofilo / One-piece profile
H 350 mm

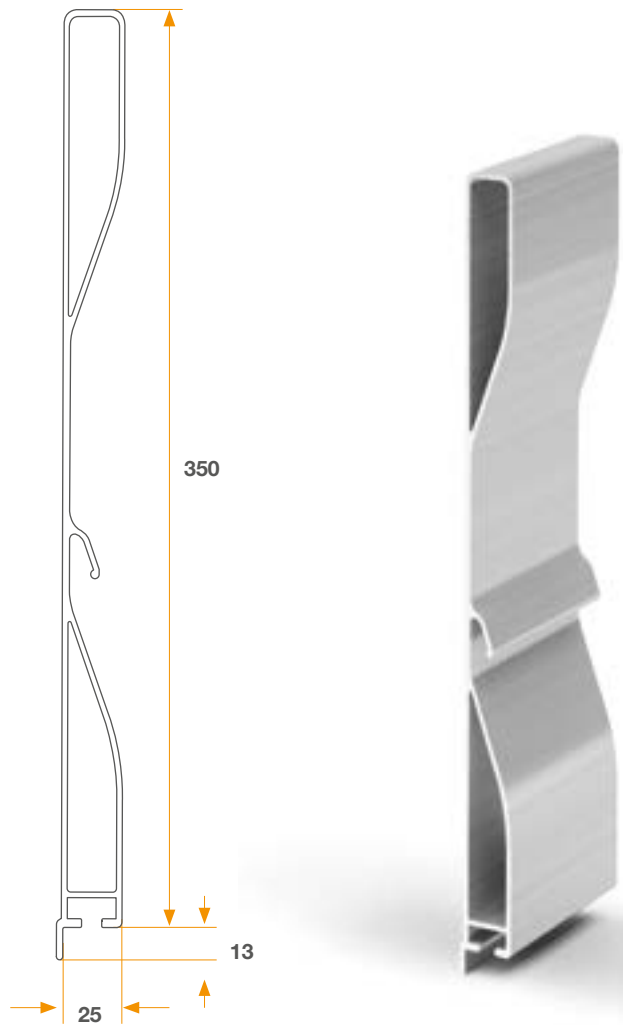

**CODICE /
PART NUMBER**
T1 4002

**PESO /
WEIGHT** kg/m
3,243

LEGA / ALLOY
EN AW-6060

04 SPONDE MONOPROFILO / ONE-PIECE PROFILES

Monoprofilo "slim" / One-piece "slim" profile
H 400 mm

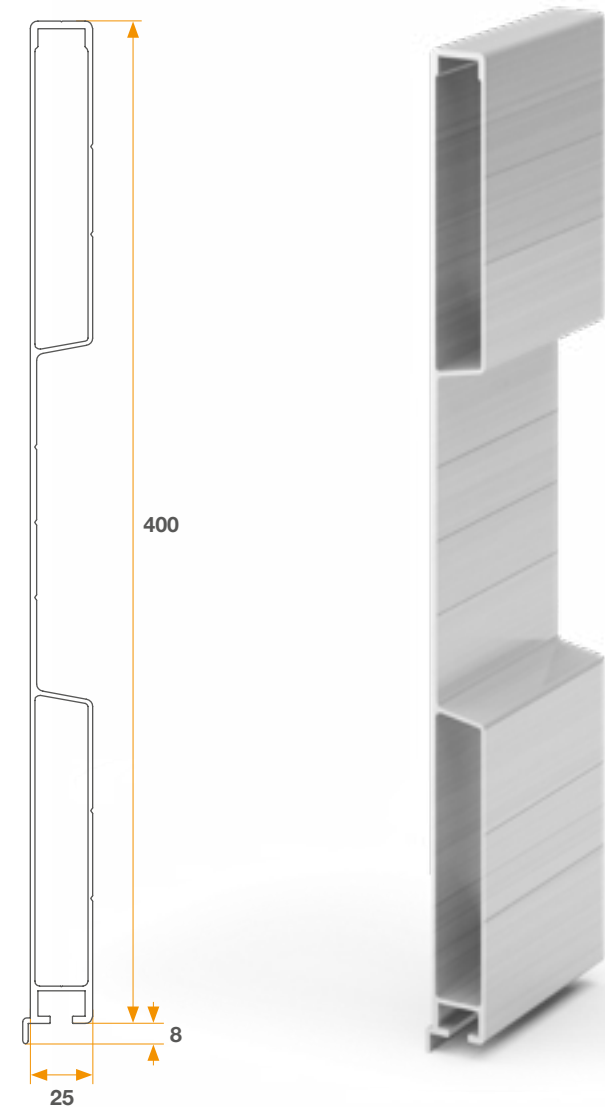

**CODICE /
PART NUMBER**
T1 4004

**PESO /
WEIGHT** kg/m
4,317

LEGA / ALLOY
EN AW-6060

04 SPONDE MONOPROFILO / ONE-PIECE PROFILES

Monoprofilo / One-piece profile
H 350 mm

CODICE /
PART NUMBER

T1 4012

PESO /
WEIGHT kg/m
3,980

LEGA / ALLOY
EN AW-6060

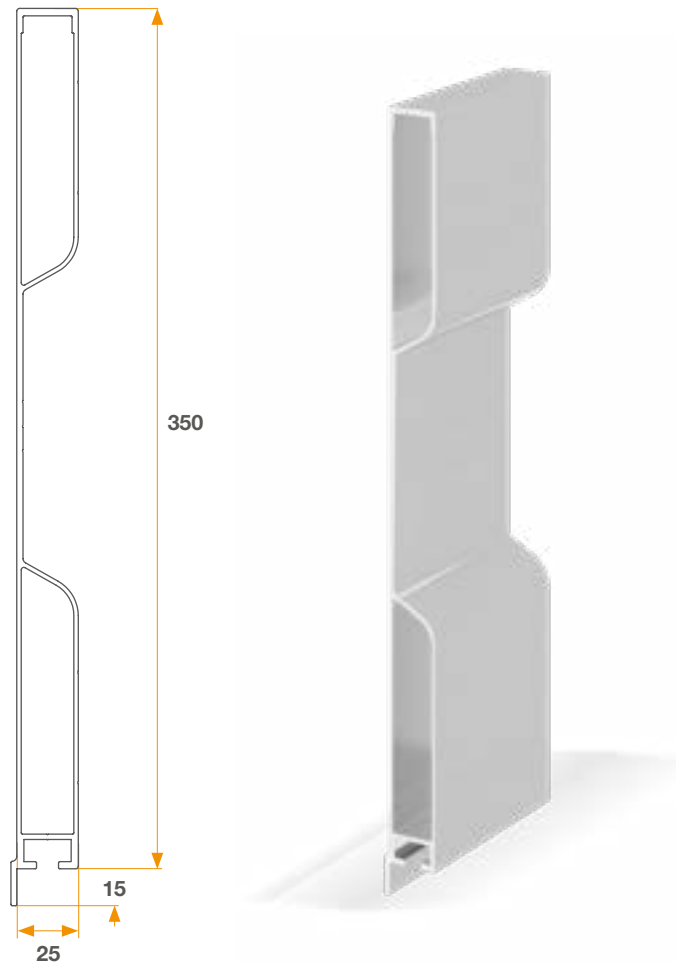

04 SPONDE MONOPROFILO / ONE-PIECE PROFILES

Monoprofilo / One-piece profile
H 300 mm

CODICE /
PART NUMBER

T1 4014

PESO /
WEIGHT kg/m
3,151

LEGA / ALLOY
EN AW-6060

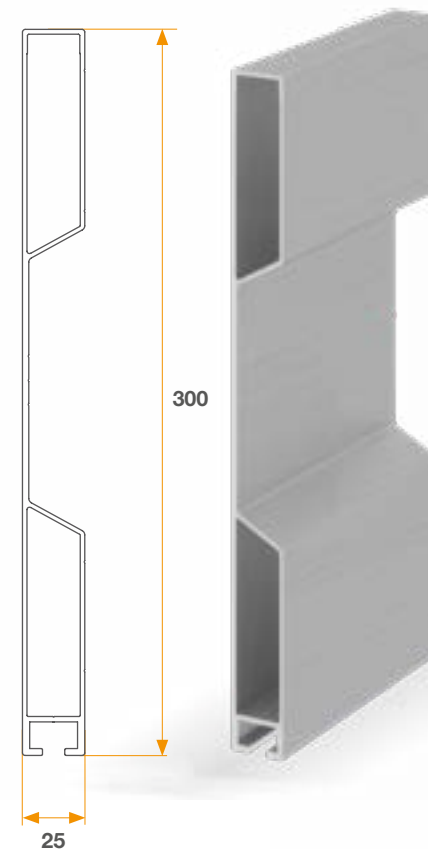

Monoprofilo / One-piece profile
H 300 mm

CODICE /
PART NUMBER

T1 4015

PESO /
WEIGHT kg/m
2,910

LEGA / ALLOY
EN AW-6060

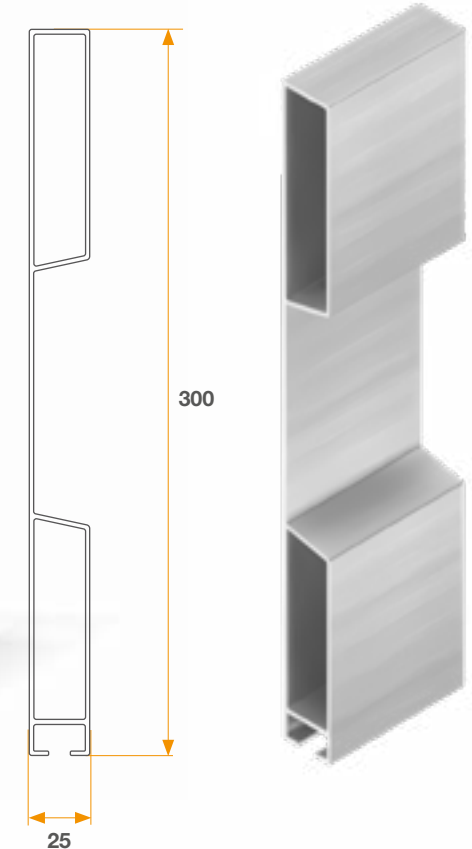

04 SPONDE MONOPROFILO / ONE-PIECE PROFILES

Monoprofilo con gancio H 157 mm / One-piece profile with hook H 157 mm
H 400 mm

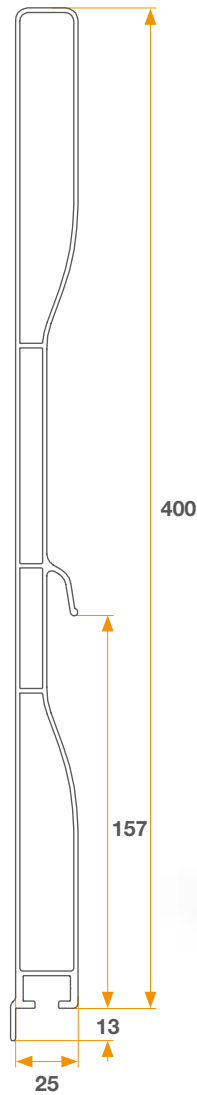

**CODICE /
PART NUMBER**
T1 4003

**PESO /
WEIGHT** kg/m
4,423

LEGA / ALLOY
EN AW-6060



04 SPONDE MONOPROFILO / ONE-PIECE PROFILES

Monoprofilo con gancio H 174 mm / One-piece profile with hook H 174 mm
H 400 mm

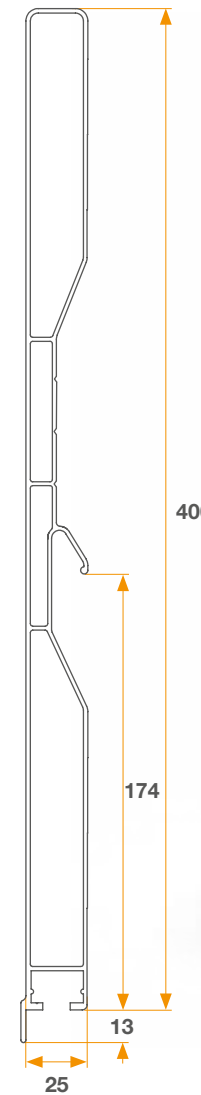

**CODICE /
PART NUMBER**
T1 4005

**PESO /
WEIGHT** kg/m
4,304

LEGA / ALLOY
EN AW-6060



04 SPONDE MONOPROFILO / ONE-PIECE PROFILES

Monoprofilo con gancio / One-piece profile with hook
H 400 mm

**CODICE /
PART NUMBER**
T1 4007

**PESO /
WEIGHT** kg/m
4,064

LEGA / ALLOY
EN AW-6060

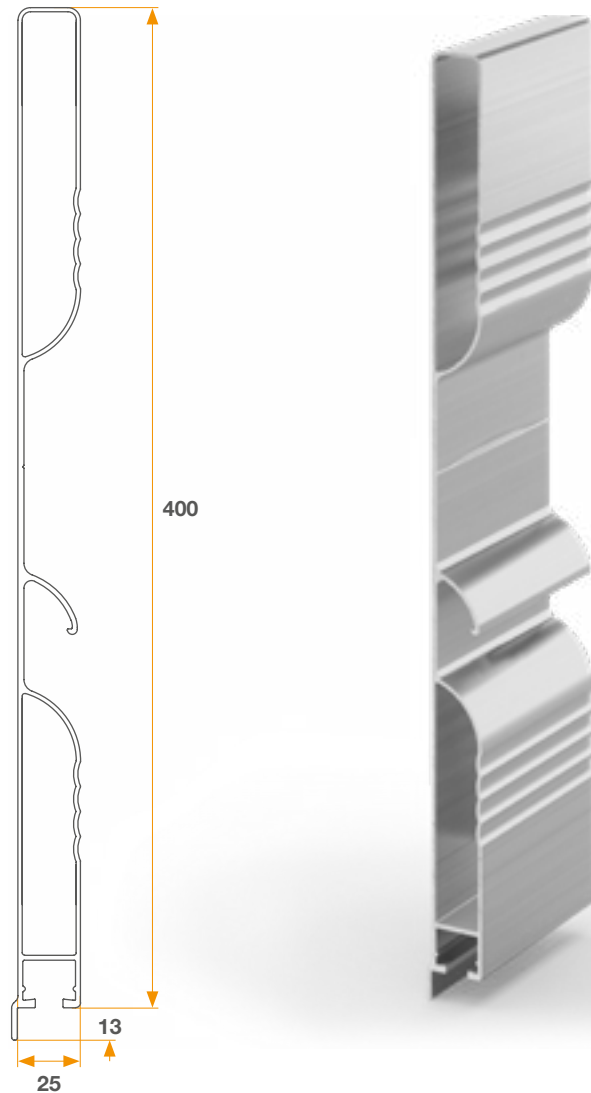

05 SPONDE PER RIBALTABILI TIPPER PROFILES

Superiore "light" / Upper "light"
H 200 mm

TR 30
**CODICE /
PART NUMBER**
T1 5001

**PESO /
WEIGHT** kg/m
3,360

LEGA / ALLOY
EN AW-6060

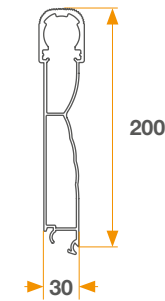

Centrale pieno "light" / Intermediate "light"
H 100 mm

TR 30
**CODICE /
PART NUMBER**
T1 5002

**PESO /
WEIGHT** kg/m
1,552

LEGA / ALLOY
EN AW-6060

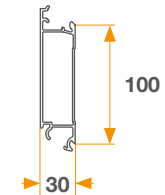

Centrale pieno "light" / Intermediate "light"
H 200 mm

TR 30
**CODICE /
PART NUMBER**
T1 5003

**PESO /
WEIGHT** kg/m
2,661

LEGA / ALLOY
EN AW-6060

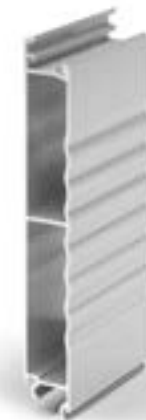
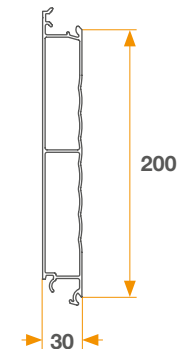

05 SPONDE PER RIBALTABILI / TIPPER PROFILES

Inferiore "light" con battuta / Lower "light" with wing
H 200 mm

TR 30

CODICE /
PART NUMBER
T1 5004

PESO /
WEIGHT kg/m
3,223

LEGA / ALLOY
EN AW-6060

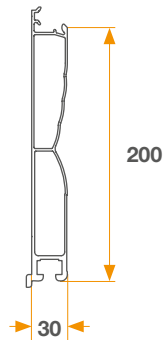

Inferiore "light" con cerniera / Lower "light" with hinge
H 200 mm

TR 30

CODICE /
PART NUMBER
T1 5006

PESO /
WEIGHT kg/m
4,381

LEGA / ALLOY
EN AW-6060

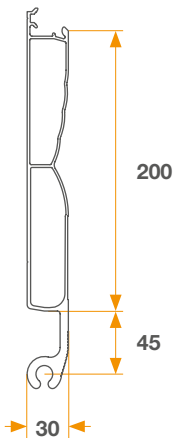

05 SPONDE PER RIBALTABILI / TIPPER PROFILES

Superiore "heavy" / Upper "heavy"
H 200 mm

TR 30

CODICE /
PART NUMBER
T1 9001

PESO /
WEIGHT kg/m
4,555

LEGA / ALLOY
EN AW-6060

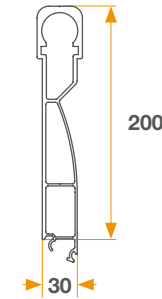

Centrale pieno "heavy" / Intermediate "heavy"
H 100 mm

TR 30

CODICE /
PART NUMBER
T1 9003

PESO /
WEIGHT kg/m
1,769

LEGA / ALLOY
EN AW-6060

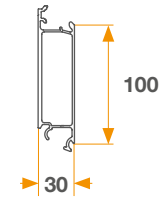

Centrale pieno "heavy" / Intermediate "heavy"
H 200 mm

TR 30

CODICE /
PART NUMBER
T1 9002

PESO /
WEIGHT kg/m
3,183

LEGA / ALLOY
EN AW-6060

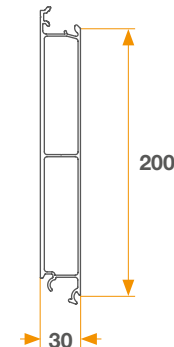

05 SPONDE PER RIBALTABILI / TIPPER PROFILES

Inferiore "heavy" con battuta / Lower "heavy" with wing
H 200 mm

TR30

CODICE /
PART NUMBER
T1 9005

PESO /
WEIGHT kg/m
3,829

LEGA / ALLOY
EN AW-6060

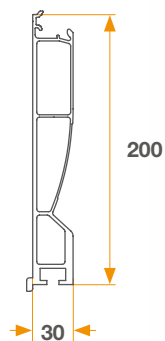

05 SPONDE PER RIBALTABILI / TIPPER PROFILES

Superiore / Upper
H 150 mm

TR5

CODICE /
PART NUMBER
T1 1038

PESO /
WEIGHT kg/m
4,285

LEGA / ALLOY
EN AW-6060

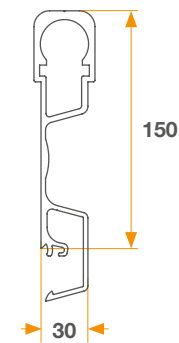

Inferiore "heavy" con cerniera /
Lower "heavy" with hinge
H 200 mm

TR30

CODICE /
PART NUMBER
T1 9004

PESO /
WEIGHT kg/m
5,216

LEGA / ALLOY
EN AW-6060

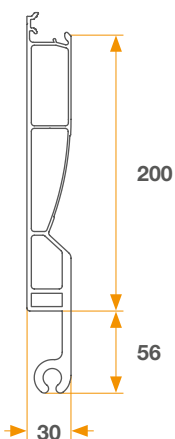

Superiore / Upper
H 200 mm

TR5

CODICE /
PART NUMBER
T1 1037

PESO /
WEIGHT kg/m
4,847

LEGA / ALLOY
EN AW-6060

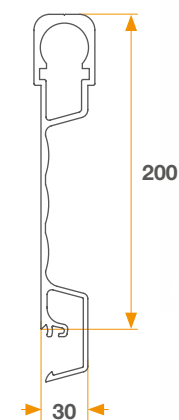

05 SPONDE PER RIBALTABILI / TIPPER PROFILES

Centrale / Intermediate
H 150 mm

TR5

CODICE /
PART NUMBER
T1 1039

PESO /
WEIGHT kg/m
2,851

LEGA / ALLOY
EN AW-6060

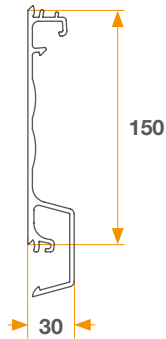

05 SPONDE PER RIBALTABILI / TIPPER PROFILES

Inferiore / Lower
H 200 mm

TR5

CODICE /
PART NUMBER
T1 1042

PESO /
WEIGHT kg/m
3,799

LEGA / ALLOY
EN AW-6060

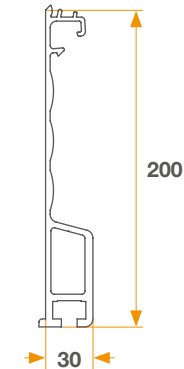

Centrale / Intermediate
H 200 mm

TR5

CODICE /
PART NUMBER
T1 1036

PESO /
WEIGHT kg/m
3,432

LEGA / ALLOY
EN AW-6060

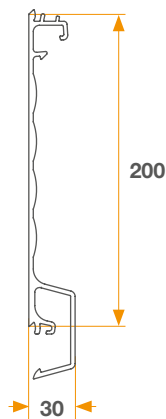

Inferiore con battuta / Lower with wing
H 200 mm

TR5

CODICE /
PART NUMBER
T1 1043

PESO /
WEIGHT kg/m
3,853

LEGA / ALLOY
EN AW-6060

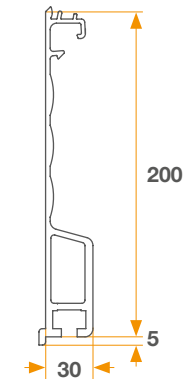

05 SPONDE PER RIBALTABILI / TIPPER PROFILES

Inferiore con cerniera / Lower with hinge
H 200 mm

TR5

CODICE /
PART NUMBER

T1 1041

PESO /
WEIGHT kg/m
5,273

LEGA / ALLOY
EN AW-6060

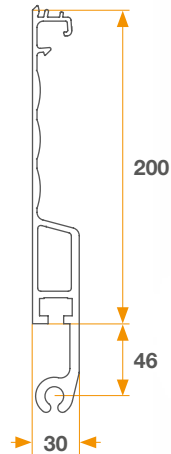

Testata per TR5 / Cover profile for TR5

TR5

CODICE /
PART NUMBER

T1 1044

PESO /
WEIGHT kg/m
1,758

LEGA / ALLOY
EN AW-6060

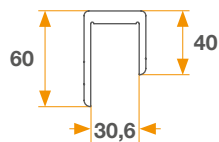

05 SPONDE PER RIBALTABILI / TIPPER PROFILES

Monoprofilo / One-piece profile
H 400 mm

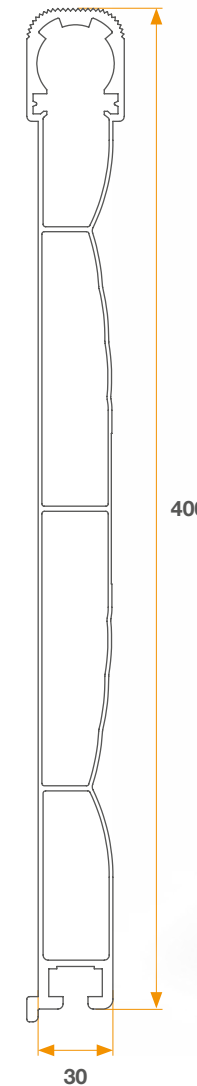

CODICE /
PART NUMBER

T1 5005

PESO /
WEIGHT kg/m
5,513

LEGA / ALLOY
EN AW-6060

05 SPONDE PER RIBALTABILI / TIPPER PROFILES

Monoprofilo / One-piece profile
H 400 mm

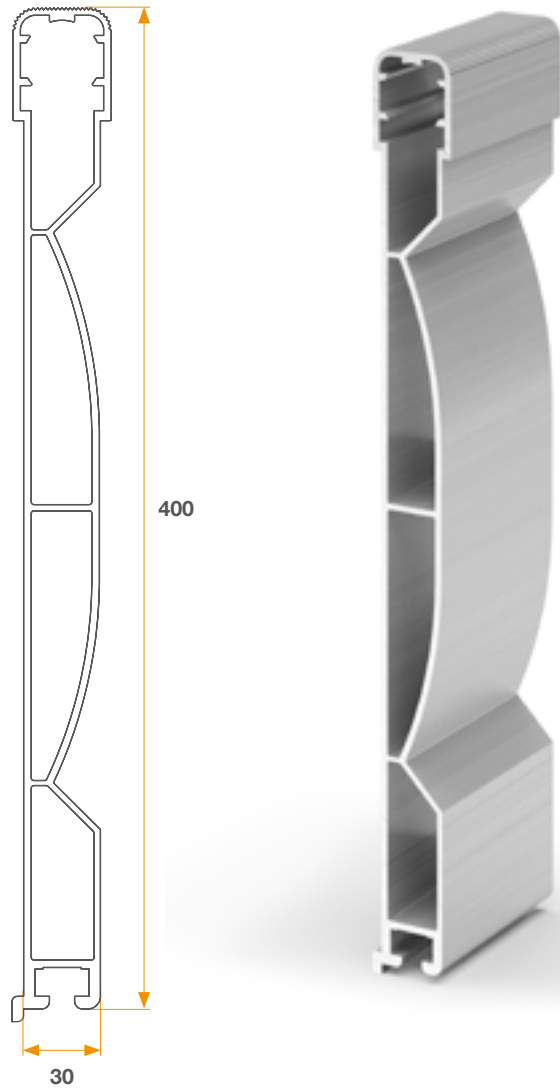

**CODICE /
PART NUMBER**
T1 5007

**PESO /
WEIGHT** kg/m
7,695

LEGA / ALLOY
EN AW-6060

05 SPONDE PER RIBALTABILI / TIPPER PROFILES

Monoprofilo con gancio / One-piece profile with hook
H 400 mm

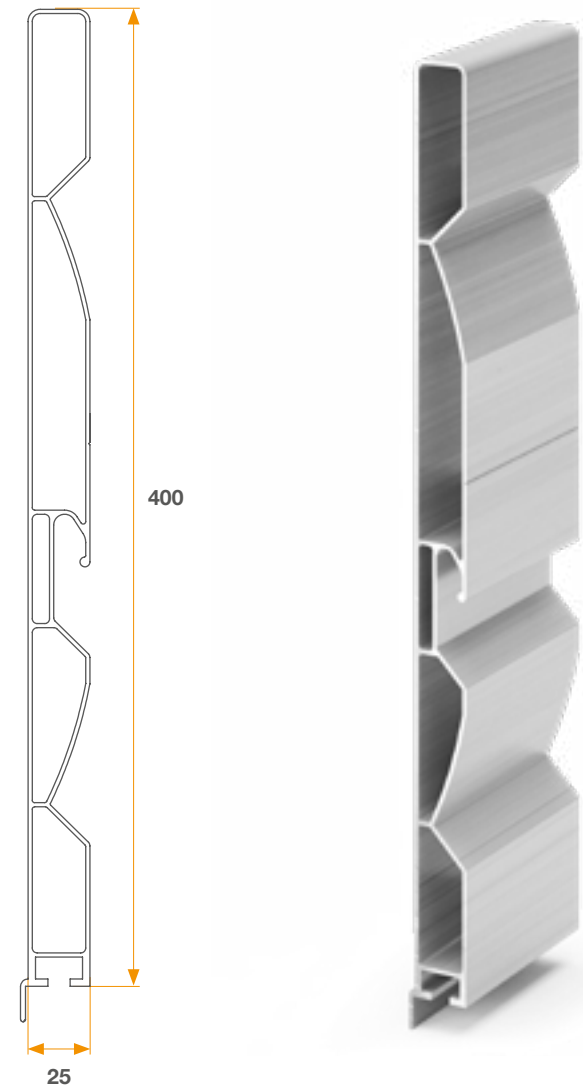

**CODICE /
PART NUMBER**
T1 5008

**PESO /
WEIGHT** kg/m
4,258

LEGA / ALLOY
EN AW-6060

05 SPONDE PER RIBALTABILI / TIPPER PROFILES

Monoprofilo TR5 / One-piece profile TR5
H 400 mm

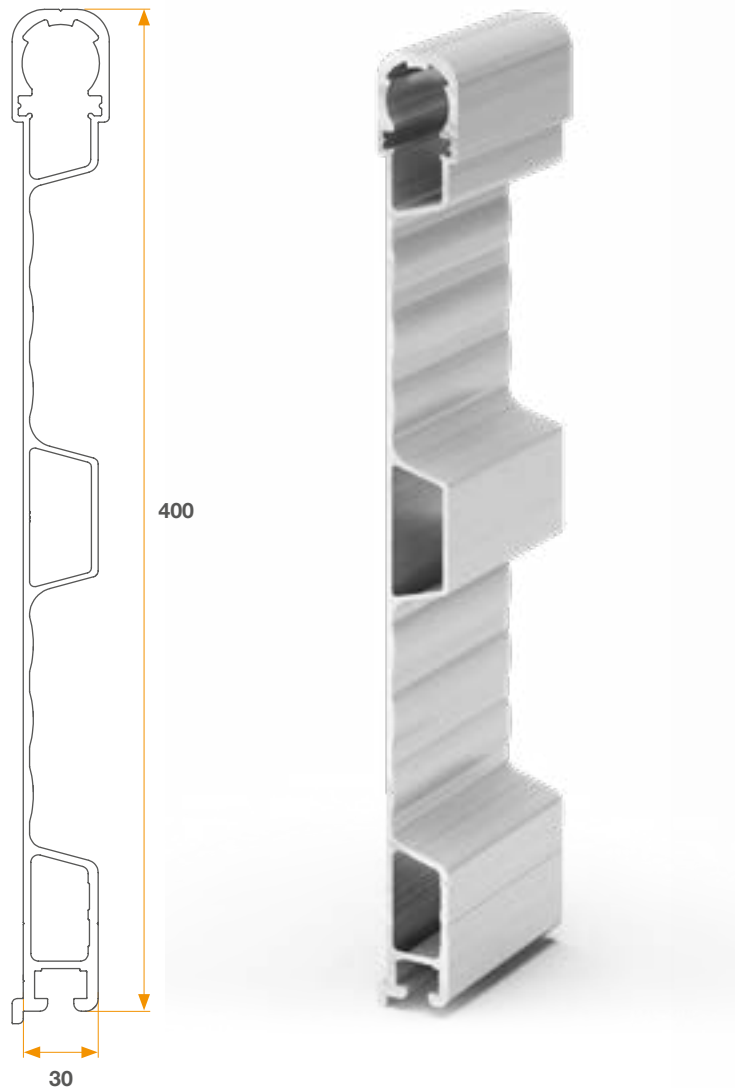

**CODICE /
PART NUMBER**
T1 5009

**PESO /
WEIGHT** kg/m
6,791

LEGA / ALLOY
EN AW-6060

06 PROFILI PER PIANALI LOADING PLATFORM PROFILES

Profilo Longherina / Side rail profile
64,8 mm X 112 mm

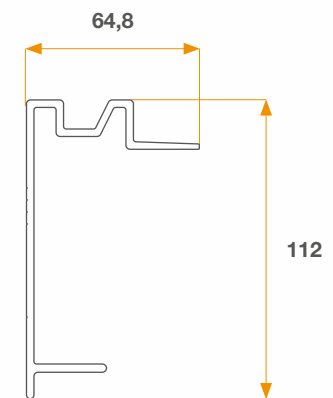

**CODICE /
PART NUMBER**
T1 6004

**PESO /
WEIGHT** kg/m
1,758

LEGA / ALLOY
EN AW-6060

06 PROFILI PER PIANALI / LOADING PLATFORM PROFILES

Pianale / Platform
200 mm X 30 mm

**CODICE /
PART NUMBER**
T1 6001

**PESO /
WEIGHT** kg/m
kg/m
3,648

LEGA / ALLOY
EN AW 6005

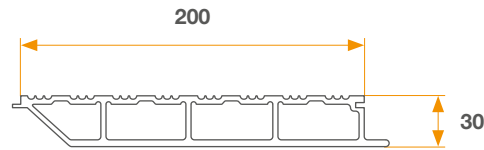

Pianale / Platform
300 mm X 40 mm

**CODICE /
PART NUMBER**
T1 6003

**PESO /
WEIGHT** kg/m
kg/m
6,907

LEGA / ALLOY
EN AW 6005

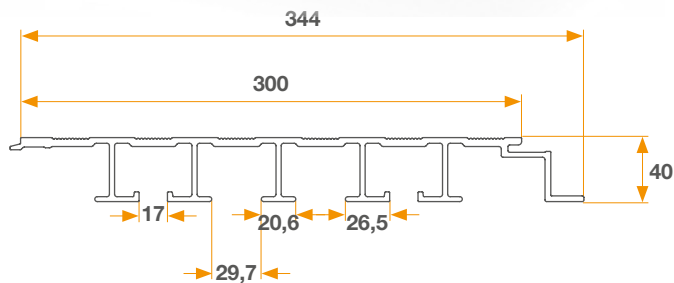
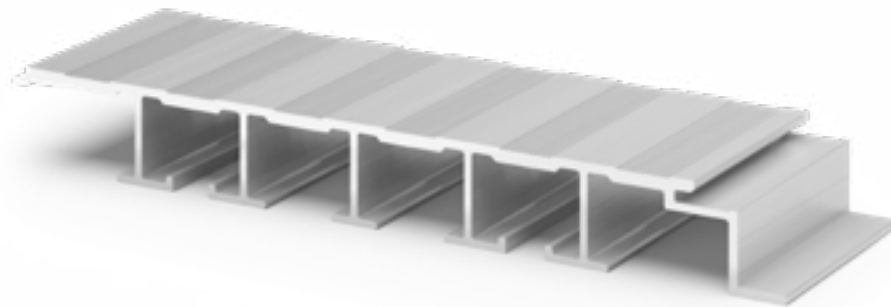

07 PROFILI PER ISOTERMICI REFRIGERATED VAN PROFILES

Profilo tetto tondo per furgonature / Round roof profile for vans

**CODICE /
PART NUMBER**
T1 7000

**PESO /
WEIGHT** kg/m
kg/m
1,990

LEGA / ALLOY
EN AW-6060

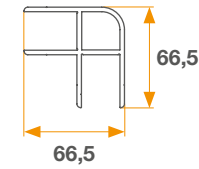

Profilo angolare piatto / Flat angular profile
60 X 40 mm

**CODICE /
PART NUMBER**
T1 7001

**PESO /
WEIGHT** kg/m
kg/m
0,575

LEGA / ALLOY
EN AW-6060

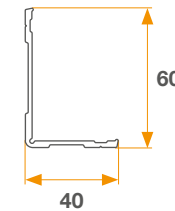

Profilo angolare piatto / Flat angular profile
60 X 80 mm

**CODICE /
PART NUMBER**
T1 7002

**PESO /
WEIGHT** kg/m
kg/m
0,832

LEGA / ALLOY
EN AW-6060

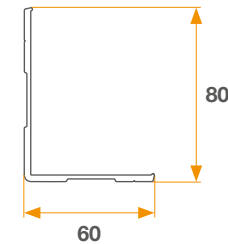

07 PROFILI PER ISOTERMICI / REFRIGERATED VAN PROFILES

Profilo angolare curvo / Curved angular profile
60 X 60 mm

**CODICE /
PART NUMBER**
T1 7004

**PESO /
WEIGHT** kg/m
0,759

LEGA / ALLOY
EN AW-6060

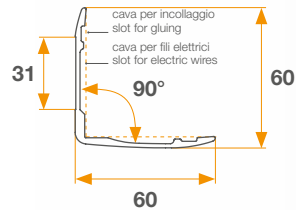

Profilo angolare curvo / Curved angular profile
60 X 60 mm

**CODICE /
PART NUMBER**
T1 7013

**PESO /
WEIGHT** kg/m
0,712

LEGA / ALLOY
EN AW-6060

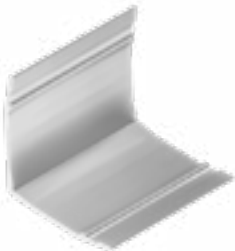
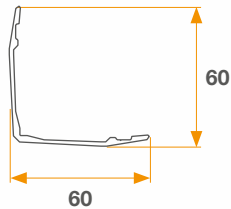

Profilo angolare curvo / Curved angular profile
60 X 80 mm

**CODICE /
PART NUMBER**
T1 7003

**PESO /
WEIGHT** kg/m
0,855

LEGA / ALLOY
EN AW-6060

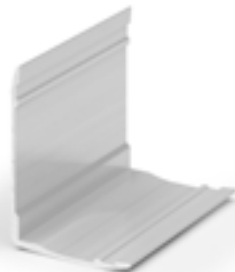
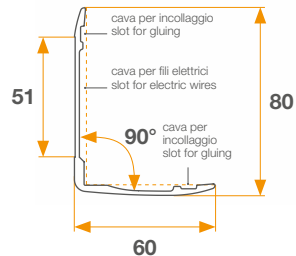

07 PROFILI PER ISOTERMICI / REFRIGERATED VAN PROFILES

Profilo angolare curvo / Curved angular profile
60 X 100 mm

**CODICE /
PART NUMBER**

T1 7009

**PESO /
WEIGHT** kg/m
0,891

LEGA / ALLOY
EN AW-6060

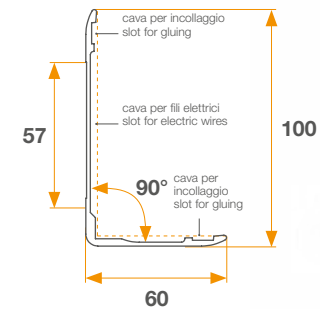

Profilo piatto rigato / Flat lined profile
H 142 mm

**CODICE /
PART NUMBER**
T1 7005

**PESO /
WEIGHT** kg/m
1,153

LEGA / ALLOY
EN AW-6060

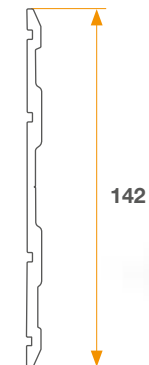

07 PROFILI PER ISOTERMICI / REFRIGERATED VAN PROFILES

Profilo guida / overhead rail profile
H 285 mm

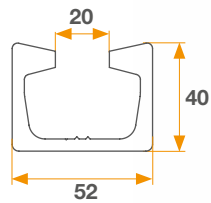

**CODICE /
PART NUMBER**
T1 7010

**PESO /
WEIGHT** kg/m
2,169

LEGA / ALLOY
EN AW-6005

07 PROFILI PER ISOTERMICI / REFRIGERATED VAN PROFILES

Profilo piatto rigato / Flat lined profile
H 260 mm

**CODICE /
PART NUMBER**
T1 7011

**PESO /
WEIGHT** kg/m
1,312

LEGA / ALLOY
EN AW-6060

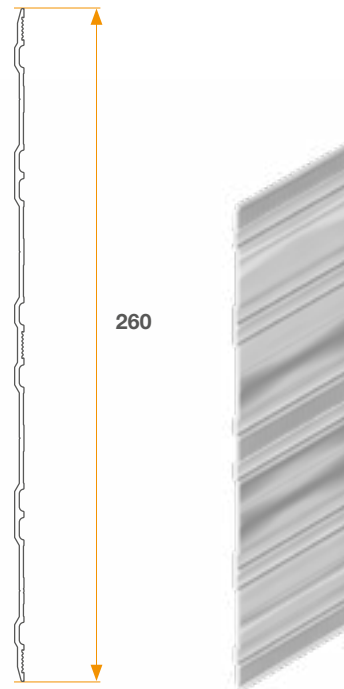

Profilo piatto rigato / Flat lined profile
H 285 mm

**CODICE /
PART NUMBER**
T1 7006

**PESO /
WEIGHT** kg/m
2,322

LEGA / ALLOY
EN AW-6060

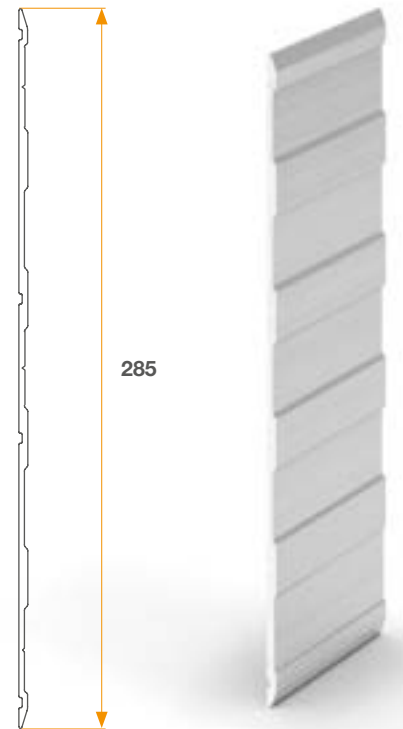

07 PROFILI PER ISOTERMICI / REFRIGERATED VAN PROFILES

Profilo a "L" rigato / "L" lined profile
H 260 mm

**CODICE /
PART NUMBER**
T1 7012

**PESO /
WEIGHT** kg/m
1,604

LEGA / ALLOY
EN AW-6060

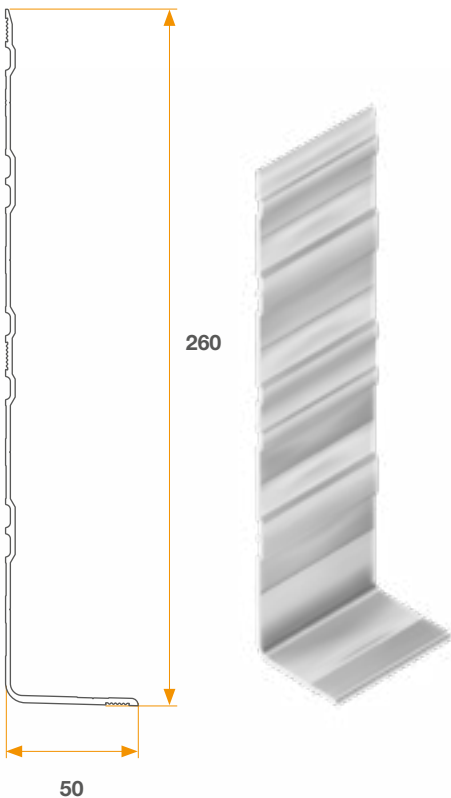

Profilo a "L" rigato / "L" lined profile
H 285 mm

**CODICE /
PART NUMBER**
T1 7008

**PESO /
WEIGHT** kg/m
2,651

LEGA / ALLOY
EN AW-6060

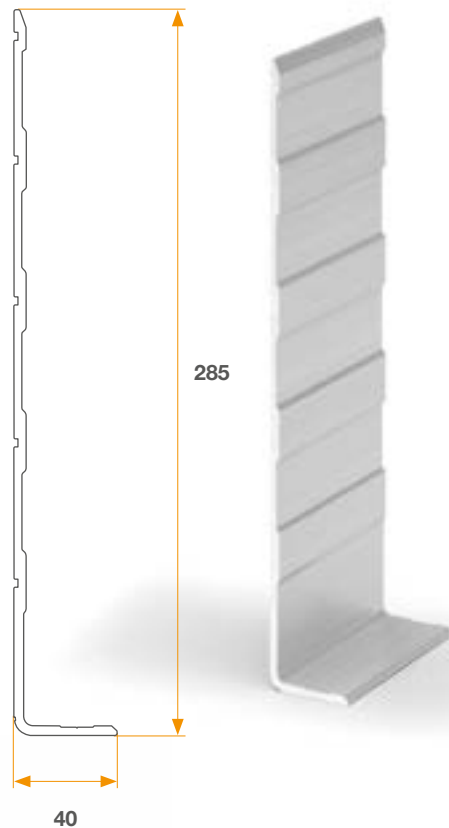

00 APPLICAZIONI VARIE MISCELLANEOUS

Profilo tensionatore / Stretching planck
88 x 28 mm

**CODICE /
PART NUMBER**
T1 8001

**PESO /
WEIGHT** kg/m
2,349

LEGA / ALLOY
EN AW-6060

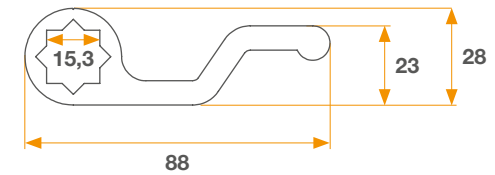

Profilo tensionatore / Stretching planck
80 x 28 mm

**CODICE /
PART NUMBER**
T1 8003

**PESO /
WEIGHT** kg/m
2,165

LEGA / ALLOY
EN AW-6060

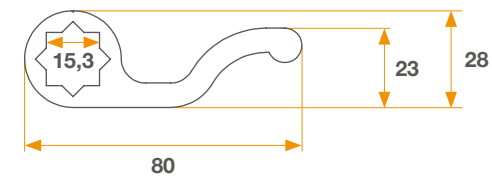

00 APPLICAZIONI / MISCELLANEOUS

Profilo tensionatore / Stretching planck
84 x 24 mm



CODICE /
PART NUMBER

T1 8009

PESO /
WEIGHT kg/m
1,625

LEGA / ALLOY
EN AW-6060

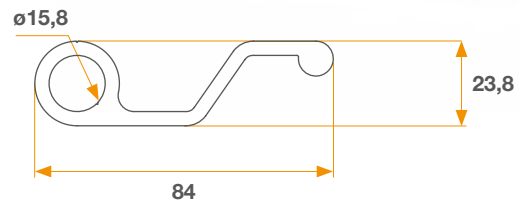

00 APPLICAZIONI / MISCELLANEOUS

Aggancio telo / Tarpaulin hook
61 x 20 mm

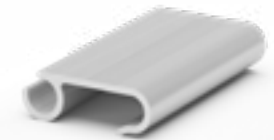

CODICE /
PART NUMBER

T1 8002

PESO /
WEIGHT kg/m
0,883

LEGA / ALLOY
EN AW-6060

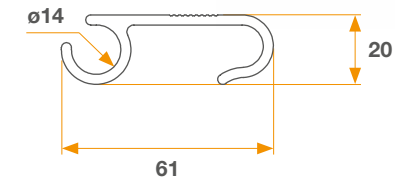

Aggancio telo / Tarpaulin hook
55 x 21 mm



CODICE /
PART NUMBER

T1 8004

PESO /
WEIGHT kg/m
0,918

LEGA / ALLOY
EN AW-6060

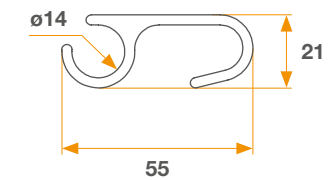

00 APPLICAZIONI / MISCELLANEOUS

Aggancio telo / Tarpaulin hook
70 x 18 mm

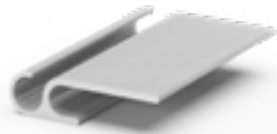

**CODICE /
PART NUMBER**
T1 8005

**PESO /
WEIGHT** kg/m
0,853
LEGA / ALLOY
EN AW-6060

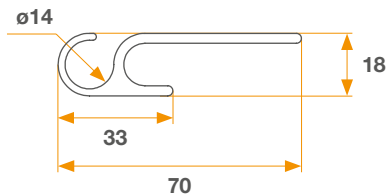

Aggancio telo / Tarpaulin hook
60 x 20 mm



**CODICE /
PART NUMBER**
T1 8006

**PESO /
WEIGHT** kg/m
0,640
LEGA / ALLOY
EN AW-6060

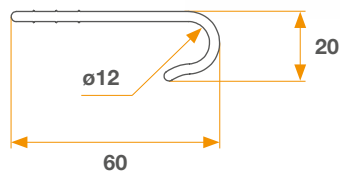

00 APPLICAZIONI / MISCELLANEOUS

Avvolgitore tendi telone / Tarpaulin tensioning pole
33x34mm

**CODICE /
PART NUMBER**
T1 8007

**PESO /
WEIGHT** kg/m
1,048
LEGA / ALLOY
EN AW-6060

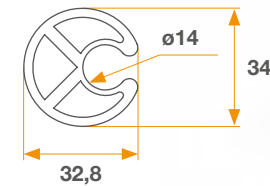

Avvolgitore tendi telone / Tarpaulin tensioning pole
32,6x34mm

**CODICE /
PART NUMBER**
T1 8012

**PESO /
WEIGHT** kg/m
0,608
LEGA / ALLOY
EN AW-6060

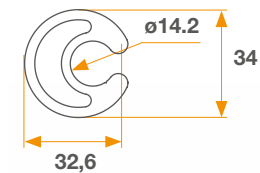

Avvolgitore tendi telone 26,5x27mm
Tarpaulin tensioning pole 26,5x27mm

**CODICE /
PART NUMBER**
T1 8008

**PESO /
WEIGHT** kg/m
0,608
LEGA / ALLOY
EN AW-6060

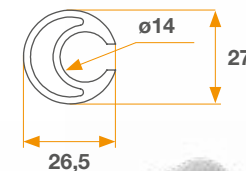

Avvolgitore tendi telone Heavy 25x25mm
Heavy Tarpaulin tensioning pole 25x25mm

**CODICE /
PART NUMBER**
T1 8013

**PESO /
WEIGHT** kg/m
0,688
LEGA / ALLOY
EN AW-6060

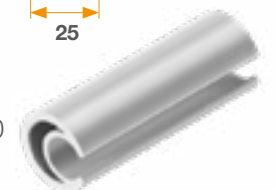
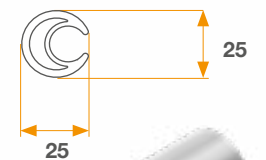

00 APPLICAZIONI / MISCELLANEOUS

Profilo tensionatore 85 x 32mm
Stretching planck 85 x 32mm



**CODICE /
PART NUMBER**

T1 8010

**PESO /
WEIGHT** kg/m
2,141

LEGA / ALLOY
EN AW-6060

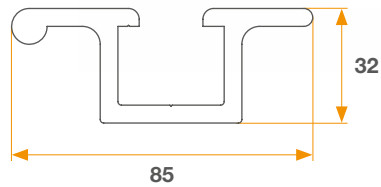

Profilo tendi telone
Tensioning pole profile



**CODICE /
PART NUMBER**

T1 8011



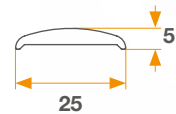

**PESO /
WEIGHT** kg/m
0,211





LEGA / ALLOY
EN AW-6060





Roof aluminium profiles

- | | | |
|-----------|---|-----|
| 01 | GUIDE PER TETTO NS2/FIX
<i>NS2/FIX ROOF GUIDE PROFILES</i> | 100 |
| 02 | GUIDE PER TETTO TOPLINE 2
<i>TOPLINE 2 ROOF GUIDE PROFILES</i> | 102 |
| 03 | GUIDE PER TETTO SMART STYLE TOPLINE 2/FIX20
<i>TOPLINE 2/FIX20 SMART STYLE ROOF GUIDE PROFILES</i> | 104 |

DESCRIZIONE / DESCRIPTION	CODICE / PART NUMBER	PESO / WEIGHT kg/m	PROFILO / PROFILE	PAGINA / PAGE
01. GUIDE PER TETTO NS2/FIX NS2/FIX ROOF GUIDE PROFILES				
GUIDA STANDARD NS-FIX 90 x 99 mm NS-FIX STANDARD GUIDE 90 x 99 mm	TO 6002	6,278		100
GUIDA STANDARD LIGHT NS-FIX 90 x 99 mm NS-FIX LIGHT STANDARD GUIDE 90 x 99 mm	TO 6005	4,779		100
GUIDA SLIM LIGHT NS-FIX 92 x 158 mm NS-FIX SLIM LIGHT GUIDE 92 x 158 mm	TO 6001	6,078		100
GUIDA SMALL NS-FIX 90 x 93 mm NS-FIX SMALL GUIDE 90 x 93 mm	TO 6004	3,442		101
GUIDA GENIUS NS-FIX 90 x 59 mm NS-FIX GENIUS GUIDE 90 x 59 mm	TO 6003	2,098		101

02. GUIDE PER TETTO TOPLINE 2 TOPLINE 2 ROOF GUIDE PROFILES				
GUIDA STANDARD BILINE TOPLINE 2 120 x 102 mm TOPLINE 2 BILINE STANDARD GUIDE 120 x 102 mm	TO 6011	5,513		102
GUIDA SLIM TOPLINE 2 120 x 158 mm TOPLINE 2 SLIM GUIDE 120 x 158 mm	TO 6012	5,927		102
GUIDA SMART TOPLINE 2 120 x 113 mm TOPLINE 2 SMART GUIDE 120 x 113 mm	TO 6010	5,119		103
GUIDA SMALL TOPLINE 2-FIX 120 x 102 mm TOPLINE 2-FIX SMALL GUIDE 120 x 102 mm	TO 6008	3,929		103
GUIDA GENIUS TOPLINE 2 120 x 66 mm TOPLINE 2 GENIUS GUIDE 120 x 66 mm	TO 6009	2,619		103

DESCRIZIONE / DESCRIPTION	CODICE / PART NUMBER	PESO / WEIGHT kg/m	PROFILO / PROFILE	PAGINA / PAGE
03. GUIDE PER TETTO SMART STYLE TOPLINE 2/FIX20 SMART STYLE TOPLINE 2/FIX20 ROOF GUIDE PROFILES				
GUIDA SMART STYLE TOPLINE 2 120 x 113 mm TOPLINE 2 SMART STYLE GUIDE 120 x 113 mm	TO 6006	5,384		104
GUIDA AL SMART STYLE TOPLINE 2 120 x 113 mm TOPLINE 2 AL SMART STYLE GUIDE 120 x 113 mm	TO 6007	5,378		104

01 GUIDE PER TETTO NS2/FIX NS2/FIX ROOF GUIDE PROFILES

GUIDA STANDARD NS-FIX / NS-FIX STANDARD GUIDE
90 x 99 mm

CODICE /
PART NUMBER
TO 6002

PESO /
WEIGHT kg/m
6,278

LEGA / ALLOY
EN AW-6005

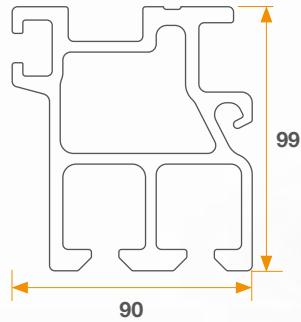

GUIDA STANDARD LIGHT NS-FIX / NS-FIX LIGHT STANDARD GUIDE
90 x 99 mm

CODICE /
PART NUMBER
TO 6005

PESO /
WEIGHT kg/m
4,779

LEGA / ALLOY
EN AW-6005

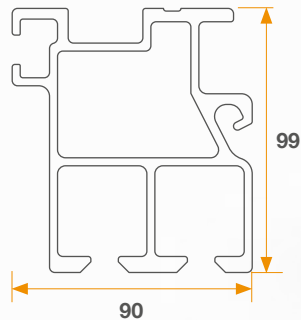

GUIDA SLIM LIGHT NS-FIX / NS-FIX SLIM LIGHT GUIDE
92 x 158 mm

CODICE /
PART NUMBER
TO 6001

PESO /
WEIGHT kg/m
6,078

LEGA / ALLOY
EN AW-6005

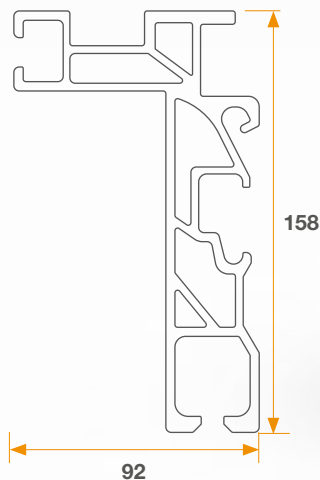

01 GUIDE PER TETTO NS2/FIX NS2/FIX ROOF GUIDE PROFILES

GUIDA SMALL NS-FIX / NS-FIX SMALL GUIDE
90 x 93 mm

CODICE /
PART NUMBER
TO 6004

PESO /
WEIGHT kg/m
3,442

LEGA / ALLOY
EN AW-6005

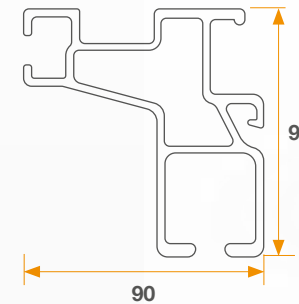

GUIDA GENIUS NS-FIX / NS-FIX GENIUS GUIDE
90 x 59 mm

CODICE /
PART NUMBER
TO 6003

PESO /
WEIGHT kg/m
2,098

LEGA / ALLOY
EN AW-6005

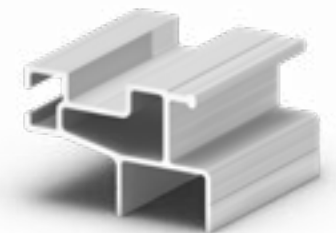
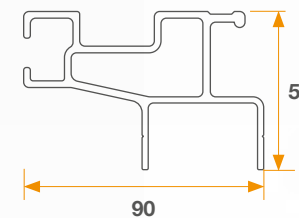

02 GUIDE PER TETTO TOPLINE 2 TOPLINE 2 ROOF GUIDE PROFILES

GUIDA STANDARD BILINE TOPLINE 2 / TOPLINE 2 BILINE STANDARD GUIDE
120 x 102 mm

**CODICE /
PART NUMBER**

TO 6011

**PESO /
WEIGHT** kg/m
5,513

LEGA / ALLOY
EN AW-6005

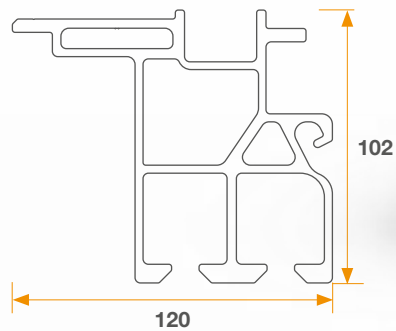

02 GUIDE PER TETTO TOPLINE 2 TOPLINE 2 ROOF GUIDE PROFILES

GUIDA SMART TOPLINE 2 / TOPLINE 2 SMART GUIDE
120 x 113 mm

**CODICE /
PART NUMBER**

TO 6010

**PESO /
WEIGHT** kg/m
5,119

LEGA / ALLOY
EN AW-6005

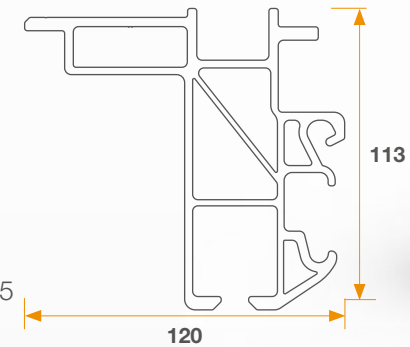

GUIDA SLIM TOPLINE 2 / TOPLINE 2 SLIM GUIDE
120 x 158 mm

**CODICE /
PART NUMBER**

TO 6012

**PESO /
WEIGHT** kg/m
5,927

LEGA / ALLOY
EN AW-6005

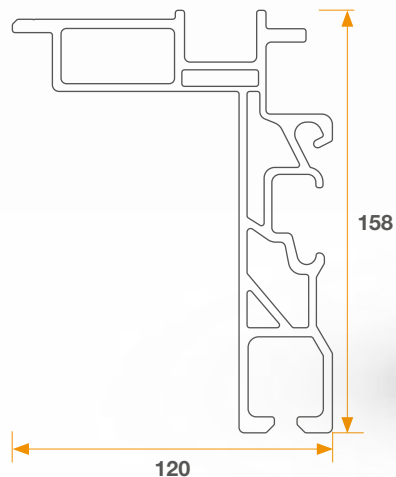

GUIDA SMALL TOPLINE 2-FIX / TOPLINE 2-FIX SMALL GUIDE
120 x 102 mm

**CODICE /
PART NUMBER**

TO 6008

**PESO /
WEIGHT** kg/m
3,929

LEGA / ALLOY
EN AW-6005

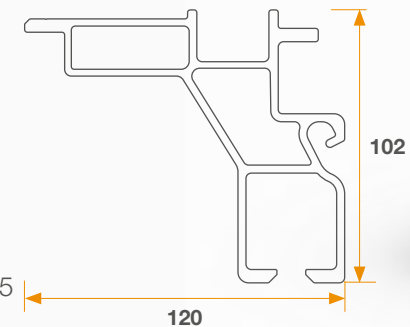

GUIDA GENIUS TOPLINE 2 / TOPLINE 2 GENIUS GUIDE
120 x 66 mm

**CODICE /
PART NUMBER**

TO 6009

**PESO /
WEIGHT** kg/m
2,619

LEGA / ALLOY
EN AW-6005

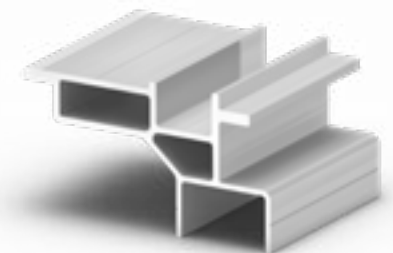
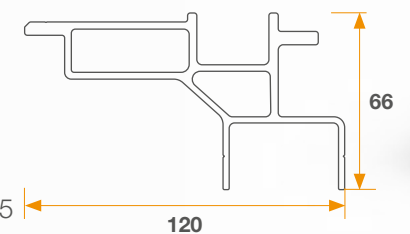

03 GUIDE PER TETTO SMART STYLE TOPLINE 2/FIX20 SMART STYLE TOPLINE 2/FIX20 ROOF GUIDE PROFILES

GUIDA SMART STYLE TOPLINE 2 / TOPLINE 2 SMART STYLE GUIDE
120 x 113 mm

CODICE /
PART NUMBER

TO 6006

PESO /

WEIGHT kg/m
5,384

LEGA / ALLOY

EN AW-6005

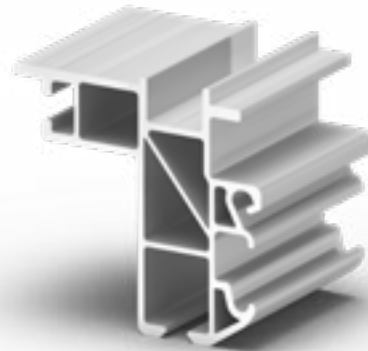
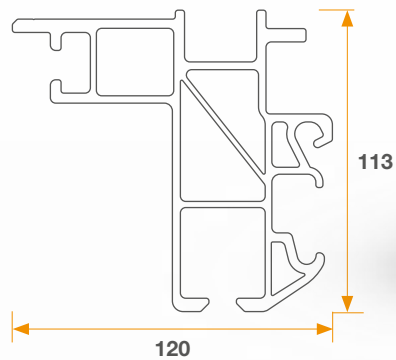

GUIDA AL SMART STYLE TOPLINE 2 / TOPLINE 2 AL SMART STYLE GUIDE
120 x 113 mm

CODICE /
PART NUMBER

TO 6007

PESO /

WEIGHT kg/m
5,378

LEGA / ALLOY

EN AW-6005

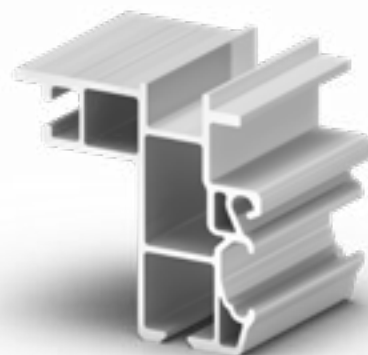
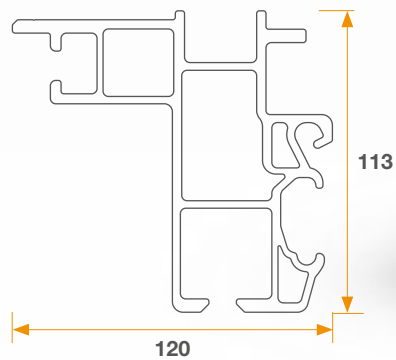

Standard aluminium profiles

01	ANGOLARI LATI UGUALI <i>ANGULARS EQUAL SIDES</i>	108
02	ANGOLARI LATI DISUGUALI <i>ANGULARS UNEQUAL SIDES</i>	109
03	PROFILI AD “U” LATI UGUALI <i>U PROFILES EQUAL SIDES</i>	110
04	PROFILI AD “U” LATI DISUGUALI <i>U PROFILES UNEQUAL SIDES</i>	111
05	TUBI QUADRI <i>SQUARE TUBES</i>	112
06	TUBI RETTANGOLARI <i>RECTANGULAR TUBES</i>	114
07	TUBI TONDI <i>ROUND TUBES</i>	116
08	PIATTI <i>PLATES</i>	117

01

ANGOLARI LATI UGUALI ANGULARS EQUAL SIDES

LEGA / ALLOY EN AW-6060

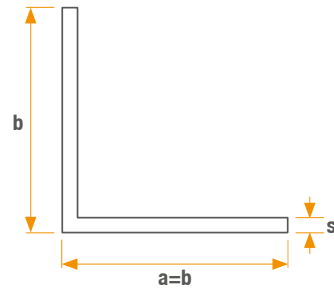
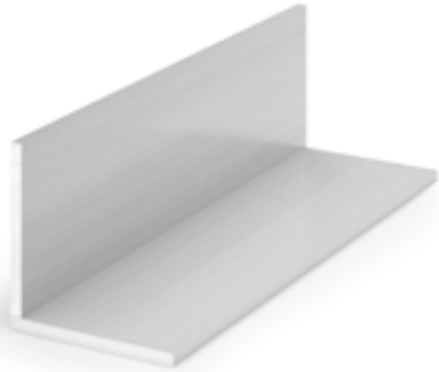

CODICE / PART NUMBER	DIMENSIONI / MEASUREMENTS mm				PESO / WEIGHT kg/m
	a	b	s	r	
T3 1008		20	1,5		0,155
T3 1001		20	2		0,205
T3 1005		25	2		0,259
T3 1006		30	1,5		0,238
T3 1002		30	2		0,313
T3 1003		40	2		0,421
T3 1009		40	4		0,82
T3 1004		50	2		0,529
T3 1007		70	3		1,109
T3 1010		50	4		1,037

02

ANGOLARI LATI DISUGUALI ANGULARS UNEQUAL SIDES

LEGA / ALLOY EN AW-6060

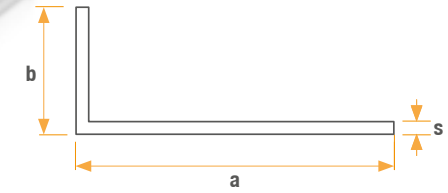
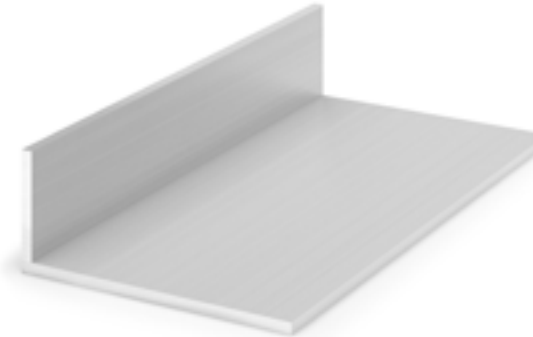

CODICE / PART NUMBER	DIMENSIONI / MEASUREMENTS mm				PESO / WEIGHT kg/m
	a	b	s	r	
T3 2001	30	15	2		0,232
T3 2013	30	20	2		0,259
T3 2002	40	20	2		0,313
T3 2007	40	25	2		0,340
T3 2004	50	20	2		0,367
T3 2008	50	25	2		0,394
T3 2012	50	30	3		0,624
T3 2003	60	20	2		0,421
T3 2009	60	30	2		0,475
T3 2005	80	20	2		0,530
T3 2011	80	40	2		0,64
T3 2010	80	50	4		1,36
T3 2006	100	20	2		0,637

03 PROFILI AD U LATI UGUALI U PROFILES EQUAL SIDES

LEGA / ALLOY EN AW-6060

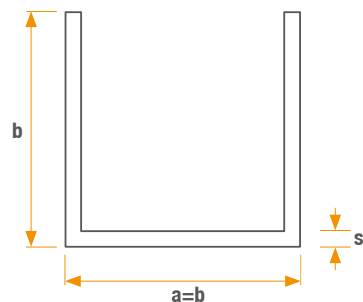

CODICE / PART NUMBER	DIMENSIONI / MEASUREMENTS mm				PESO / WEIGHT kg/m
	a	b	s	r	
T3 3001	60	60	4		1,857

04 PROFILI AD U LATI DISUGUALI U PROFILES UNEQUAL SIDES

LEGA / ALLOY EN AW-6060

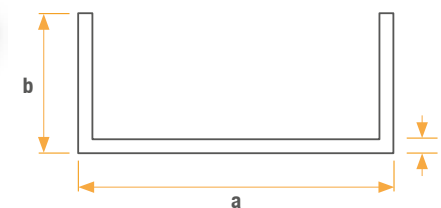
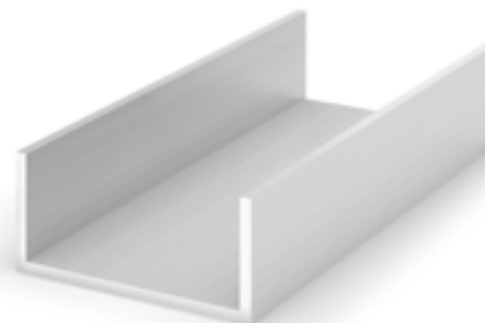

CODICE / PART NUMBER	DIMENSIONI / MEASUREMENTS mm				PESO / WEIGHT kg/m
	a	b	s	r	
T3 4010	20	9	1,2		0,115
T3 4006	20	30	2		0,411
T3 4007	40	15	3		0,518
T3 4004	45	20	2		0,448
T3 4009	55	40	2		0,706
T3 4002	80	20	2		0,627
T3 4013	80	40	5		2,02
T3 4005	95	20	2		0,707
T3 4001	100	20	2		0,735
T3 4011	100	50	5		2,564
T3 4003	120	20	1,5		0,637
T3 4012	120	20	2		0,842
T3 4008	120	30	1,6		0,763

05 TUBI QUADRI | SPIGOLI ARROTONDATI

SQUARE TUBES | SMOOTHED EDGES

LEGA / ALLOY EN AW-6060

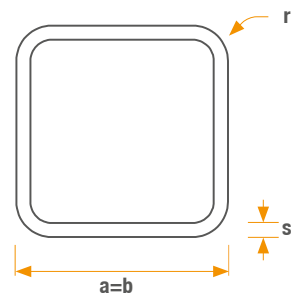

CODICE / PART NUMBER	DIMENSIONI / MEASUREMENTS mm				PESO / WEIGHT kg/m
	a	b	s	r	
T3 5001	30	2	5	0,567	
T3 5002	35	2,3	1,5	0,8	
T3 5024	25	2	1,5	0,491	
T3 5025	30	3	3	0,856	

05 TUBI QUADRI | SPIGOLI VIVI

SQUARE TUBES | SHARP EDGES

LEGA / ALLOY EN AW-6060

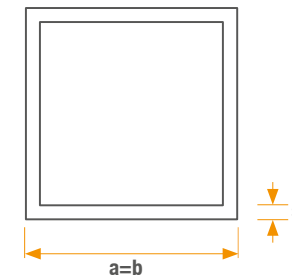
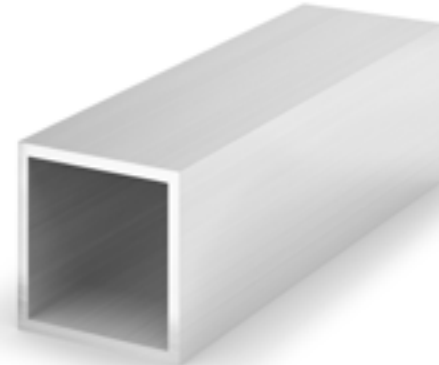

CODICE / PART NUMBER	DIMENSIONI / MEASUREMENTS mm				PESO / WEIGHT kg/m
	a	b	s	r	
T3 5018	15	1,5	0,219		
T3 5021	20	1,5	0,3		
T3 5006	20	2	0,390		
T3 5017	25	1,5	0,38		
T3 5008	25	2	0,497		
T3 5016	30	1,5	0,461		
T3 5003	30	2	0,605		
T3 5010	35	2	0,715		
T3 5004	40	2	0,820		
T3 5012	40	3	1,198		

CODICE / PART NUMBER	DIMENSIONI / MEASUREMENTS mm				PESO / WEIGHT kg/m
	a	b	s	r	
T3 5007	45	2	0,929		
T3 5005	50	2	1,037		
T3 5013	50	3	1,522		
T3 5009	60	2	1,253		
T3 5014	60	3	1,846		
T3 5019	60	4	2,419		
T3 5011	80	2	1,685		
T3 5015	80	4	3,283		
T3 5022	100	2	2,12		
T3 5020	100	4	4,147		

06 TUBI RETTANGOLARI | SPIGOLI ARROTONDATI RECTANGULAR TUBES | SMOOTHED EDGES

LEGA / ALLOY EN AW-6060

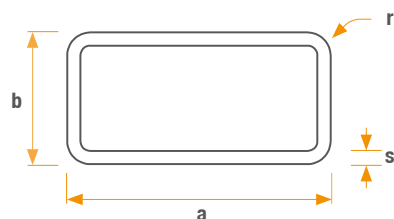

CODICE / PART NUMBER	DIMENSIONI / MEASUREMENTS mm				PESO / WEIGHT kg/m
	a	b	s	r	
T3 6001	30	18	1,5	3,5	0,345
T3 6005	40	10	1,5	2,5	0,368
T3 6002	40	20	2	2,5	0,6
T3 6006	50	30	1,5	2,5	0,612
T3 6008	50	30	2	5	0,784
T3 6003	50	30	2,5	1,5	1,01
T3 6004	70	35	1,5	3	0,83
T3 6007	130	30	1,8	5	1,486
T3 6049	50	35	3-4	2	1,509
T3 6050	120	40	4	2	3,275

06 TUBI RETTANGOLARI | SPIGOLI VIVI RECTANGULAR TUBES | SHARP EDGES

LEGA / ALLOY EN AW-6060

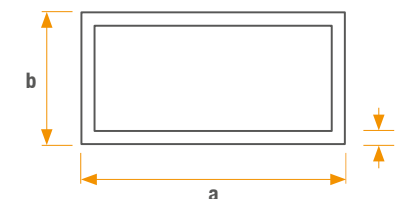
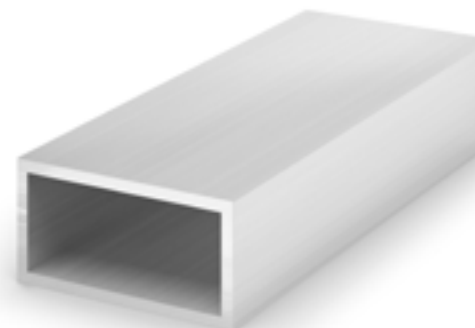

CODICE / PART NUMBER	DIMENSIONI / MEASUREMENTS mm				PESO / WEIGHT kg/m
	a	b	s	r	
T3 6009	20	10	1,5		0,219
T3 6033	20	15	2		0,335
T3 6017	30	15	1,5		0,340
T3 6010	30	15	2		0,443
T3 6025	30	20	2		0,259
T3 6039	33	6,5	1,5		0,246
T3 6038	35	15	1,5		0,38
T3 6037	40	15	1,5		0,421
T3 6018	40	20	1,5		0,462
T3 6011	40	20	2		0,605
T3 6019	45	25	1,5		0,542
T3 6042	48	18	1,3		0,444
T3 6027	50	20	2		0,713
T3 6020	50	25	1,5		0,583
T3 6021	50	25	2		0,767
T3 6030	50	30	2		0,82
T3 6045	60	20	1,1		0,462
T3 6031	60	20	2		0,82
T3 6012	60	30	2		0,928

CODICE / PART NUMBER	DIMENSIONI / MEASUREMENTS mm				PESO / WEIGHT kg/m
	a	b	s	r	
T3 6040	60	30	3		1,361
T3 6028	60	40	2		1,037
T3 6013	80	15	1,5		0,745
T3 6026	80	20	2		1,037
T3 6029	80	40	1,4		0,886
T3 6015	80	40	2		1,253
T3 6034	80	40	4		2,419
T3 6022	100	20	2		1,253
T3 6023	100	30	2		1,382
T3 6024	100	40	2		1,469
T3 6041	100	40	4		2,851
T3 6016	100	50	2		1,577
T3 6035	100	50	3		2,332
T3 6032	120	20	2		1,47
T3 6044	120	60	2		1,908
T3 6014	140	20	2		1,685
T3 6043	150	50	2		2,12
T3 6036	150	50	3		3,142

07 TUBI TONDI ROUND TUBES

LEGA / ALLOY **EN AW-6060**

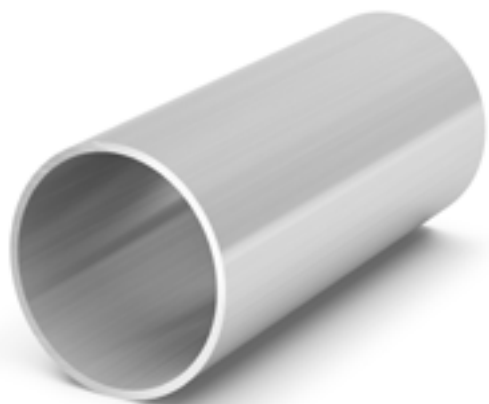

Pieno / Full

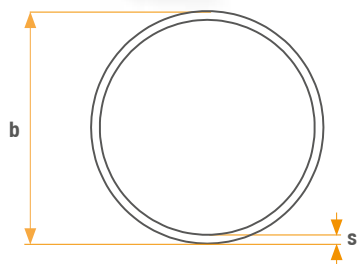

CODICE / PART NUMBER	DIMENSIONI / MEASUREMENTS mm				PESO / WEIGHT kg/m
	a	b	s	r	
T3 7009		13	2		0,186
T3 7021		20	1,5		0,235
T3 7007		20	2,5		0,371
T3 7016		22	1,5		0,26
T3 7018		22	3		0,483
T3 7017		25	1,5		0,299
T3 7020		30	1,5		0,363
T3 7001		30	2		0,475
T3 7010		33	2		0,525
T3 7002		35	1,5		0,426
T3 7004		40	1,5		0,49
T3 7019		48	2,8		1,072
T3 7014		48	4		1,492
T3 7015		50	1,5		0,617

CODICE / PART NUMBER	DIMENSIONI / MEASUREMENTS mm				PESO / WEIGHT kg/m
	a	b	s	r	
T3 7003		50	2		0,814
T3 7022		50	3		1,196
T3 7028		50	5		1,909
T3 7006		54	2,5		1,092
T3 7011		60	1,5		0,744
T3 7005		60	2		0,984
T3 7026		60	3		1,45
T3 7013		75	5		2,968
T3 7008		110	2		1,832
T3 7027		100	2,8		2,308
T3 7012		110	5		4,453
T3 7024		22	pieno		1,026
T3 7025		25	pieno		1,325
T3 7023		35	pieno		2,6

08 PIATTI | SPIGOLI VIVI PLATES | SHARP EDGES

LEGA / ALLOY **EN AW-6060**



CODICE / PART NUMBER	DIMENSIONI / MEASUREMENTS mm				PESO / WEIGHT kg/m
	a	b	s	r	
T3 8002	30		5		0,405
T3 8003	40		5		0,54
T3 8001	50		2		0,27
T3 8004	60		2		0,324
T3 8005	70		5		0,944
T3 8006	150		4		1,62
T3 8011	70		30		5,67

08

PIATTI | SPIGOLI ARROTONDATI PLATES | SMOOTHED EDGES

LEGA / ALLOY **EN AW-6060**

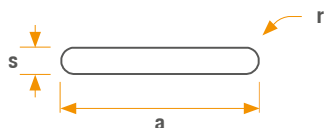

CODICE / PART NUMBER	DIMENSIONI / MEASUREMENTS mm				PESO / WEIGHT kg/m
	a	b	s	r	
T3 8008	30		3,5	1,75	0,276
T3 8007	30		4	2	0,314
T3 8009	40		4	2	0,856
T3 8010	60		12	2	1,936

NOTE TECNICHE TECHNICAL NOTES

LEGHE DI ESTRUSIONE

Le leghe degli estrusi Takler sono EN AW-6060, EN AW-6005A e EN AW-6063.

Per maggiori dettagli tecnici consultare le tabelle riportate nelle pagine seguenti.

EXTRUSION ALLOYS

Takler extruded profiles are made of the following alloys: EN AW-6060, EN AW-6005A and EN AW-6063.

For further info, please check the data sheets provided herewith.

PESO DEGLI ESTRUSI

Il peso degli estrusi riportato sul presente catalogo è quello teorico: potrebbe variare in funzione delle tolleranze dimensionali e di forma, regolamentate dalle norme UNI EN 755-3, 4, 5, 6, 7, 8, 9.

EXTRUDED PROFILES-WEIGHT

The weight of the extruded profiles is indicative: it may vary depending on the tolerances given by dimensions and shape, in compliance with UNI EN 755-3, 4, 5, 6, 7, 8, 9.

DIMENSIONI DEGLI ESTRUSI

Le dimensioni degli estrusi riportate sul presente catalogo sono quelle teoriche: potrebbero variare in funzione delle tolleranze dimensionali e di forma, regolamentate dalle norme UNI EN 755-3, 4, 5, 6, 7, 8, 9. Questa variabilità dimensionale potrebbe influenzare le lunghezze del taglio e quindi le dimensioni dell'estruso.

EXTRUDED PROFILES-DIMENSIONS

The dimensions of the extruded profiles are indicative: they may vary depending on the tolerances given by dimensions and shape, in compliance with UNI EN 755-3, 4, 5, 6, 7, 8, 9. Such variability in dimensions may affect the final cutting lengths and therefore the dimensions of the extrude profile itself.

LUNGHEZZA DEGLI ESTRUSI

Le lunghezze commerciali degli estrusi per la categoria Trucks & Trailers vanno da un minimo di 4500 mm ad un massimo di 7600 mm. La lunghezza commerciale per la categoria Standard è di 6500 mm. Per eventuali dimensioni differenti contattare il nostro Ufficio Vendite.

EXTRUDES PROFILES-LENGTHS

Commercial lengths for extruded profiles - Trucks & Trailers section - go from a minimum of 4500 mm to a maximum of 7600 mm. For Standard section profiles, the commercial length is 6500 mm. For non-standard requirements, please contact our Sales Department.

EN AW-6060

LEGA DI ALLUMINIO DA ESTRUSIONE / EXTRUSION ALUMINIUM ALLOY

La lega EN AW-6060 è la lega da estrusione più diffusa sul mercato europeo, per le sue doti di alta velocità di deformazione a caldo. Essa consente la realizzazione di profilati con sezione anche complessa, comprendente molteplici cavità e scanalature, per avvicinare quanto più possibile il disegno dell'estruso a quello del manufatto finito e ridurre al minimo le lavorazioni intermedie.

The alloy type EN AW - 6060 is the most popular alloy on the European market, thanks to its high deformation speed under heat. It is used to produce sections, even with complex cross sections, that include many hollows and groves, so that the design of the extruded piece is as near as possible to the finished article and to reduce intermediary processes.

Caratteristiche fisiche / Physical characteristics

Massa volumica / Volume mass	2,70 g / cm ³	
Punto di fusione inferiore / Lower melting point	605 °C	
Calore specifico tra 0° e 100°C / Specific heat between 0° and 100°C	890 J / Kg °K	
Modulo di elasticità lineare E / Linear modulus of elasticity E	69000 N / mm ²	
Modulo elasticità tangenziale G / Tangential modulus of elasticity G	26000 N / mm ²	
Conducibilità termica a 20°C Thermal conductivity at 20°C	Nello stato O / In state O	2,09 W / cm °K
	Nello stato T6 / In state T6	1,75 W / cm °K
Coefficiente di dilatazione termica lineare Linear thermal expansion coefficient	Tra 20° e 100°C / 20° - 100°C	23,0 · 10 ⁻⁶ 1 / °K
	Tra 20° e 200°C / 20° - 200°C	24,0 · 10 ⁻⁶ 1 / °K
	Tra 20° e 300°C / 20° - 300°C	25,0 · 10 ⁻⁶ 1 / °K
Resistività elettrica a 20°C Electrical resistivity at 20°C	Nello stato O / In state O	3,14 μΩ · cm
	Nello stato T6 / In state T6	3,25 μΩ · cm

Composizione chimica secondo Norma Europea EN 573.3 / Chemical composition according to European Standard EN 573.3

	Si	Fe	Cu	Mn	Mg	Cr	Zn	Ti	ALTRI / OTHERS		Al
									Ciascuno Each	Totale Total	
EN AW - 6060	0,30 ± 0,60	0,10 ± 0,30	0,10 max	0,10 max	0,35 ± 0,60	0,05 max	0,15 max	0,10 max	0,05 max	0,15 max	resto resto

Proprietà meccaniche minime, secondo Norma Europea EN 755.2 / Minimum mechanical properties, according to European Standard EN 755.2

TIPI DI PROFILO TYPES OF PROFILE	Stato fisico di fornitura Temper state	Diametro D [mm] per tondi, o spess. S [mm] per barre, o di parete e per profili Diameter D [mm] for rods or thickness TH [mm] for bars or thickness of walls and for sections		Carico di rottura a trazione R _m [MPa] Tensile strength R _m [MPa]		Carico limite di elasticità R _{p0.2} [MPa] Limit elasticity load R _{p0.2} [MPa]		Allungamento Elongation	
		min	max	min	max	A % min	A _{50mm} % min		
BARRI PIENE FULL BARS	T4	D ≤ 150	S ≤ 150	120	-	60	-	16	14
	T5	D ≤ 150	S ≤ 150	160	-	120	-	8	6
	T6	D ≤ 150	S ≤ 150	190	-	150	-	8	6
	T64	D ≤ 50	S ≤ 50	180	-	120	-	12	10
TUBO ESTRUSO EXTRUDED PIPE	T66	D ≤ 150	S ≤ 150	215	-	160	-	8	6
	T4	e ≤ 15		120	-	60	-	16	14
	T5		160	-	120	-	8	6	
	T6		190	-	150	-	8	6	
T64	180		-	120	-	12	10		
PROFILI APERTI E CAVI SECTIONS	T66			215	-	160	-	8	6
	T4	e ≤ 25		120	-	60	-	16	14
	T5	e ≤ 5		160	-	120	-	8	6
		5 < e < 25		140	-	100	-	8	6
	T6	e ≤ 3		190	-	150	-	8	6
		3 < e < 25		170	-	140	-	8	6
T64	e ≤ 15		180	-	120	-	12	10	
T66	e ≤ 3		215	-	160	-	8	6	
	3 < e < 25		195	-	150	-	8	6	

EN AW-6005 A

LEGA DI ALLUMINIO DA ESTRUSIONE / EXTRUSION ALUMINIUM ALLOY

I manufatti e strusi in lega d'alluminio EN AW 6005 A trovano impiego nei settori dell'industria, dell'edilizia e dell'ingegneria in genere, ove sussistono i requisiti di media resistenza meccanica, anche su parti saldate, associati a buona resistenza alla corrosione. La composizione chimica e i processi produttivi adottati conferiscono a questa lega la capacità di acquisire facilmente la tempera; di conseguenza le proprietà meccaniche sono raggiunte anche in quelle parti del profilo non pienamente esposte allo scambio termico.

Extruded products in aluminium alloy type EN AW 6005 A are used in the industrial, building and general engineering sectors, which require medium mechanical resistance, even on welded parts, associated with good resistance to corrosion. The chemical composition and the production processes adopted make this alloy easy to harden and temper. The mechanical properties are consequently reached even in parts of the profile that are not fully exposed to the thermal exchange.

Caratteristiche fisiche / Physical characteristics

Massa volumica / Volume mass	2,71 g / cm ³	
Punto di fusione inferiore / Lower melting point	615 °C	
Calore specifico tra 0° e 100°C / Specific heat between 0° and 100°C	897 J / Kg °K	
Modulo di elasticità lineare E / Linear modulus of elasticity E	69000 N / mm ²	
Modulo elasticità tangenziale G / Tangential modulus of elasticity G	26000 N / mm ²	
Conducibilità termica a 20°C Thermal conductivity at 20°C	Nello stato O / In state O	2,09 W / cm °K
	Nello stato T6 / In state T6	1,72 W / cm °K
Coefficiente di dilatazione termica lineare Linear thermal expansion coefficient	Tra 20° e 100°C / 20° - 100°C	23,2 · 10 ⁻⁶ 1 / °K
	Tra 20° e 200°C / 20° - 200°C	24,1 · 10 ⁻⁶ 1 / °K
	Tra 20° e 300°C / 20° - 300°C	25 · 10 ⁻⁶ 1 / °K
Resistività elettrica a 20°C Electrical resistivity at 20°C	Nello stato O / In state O	3,14 μΩ · cm
	Nello stato T6 / In state T6	3,85 μΩ · cm

Composizione chimica secondo Norma Europea EN 573.3 / Chemical composition according to European Standard EN 573.3

	Si	Fe	Cu	Mn	Mg	Cr	Zn	Ti	ALTRI / OTHERS		Al
									Ciascuno Each	Totale Total	
EN AW -6005A	0,50 ± 0,90	0,35 max	0,30 max	0,50 max	0,40 ± 0,70	0,30 max	0,20 max	0,10 max	0,05 max	0,15 max	resto rest

Proprietà meccaniche minime, secondo Norma Europea EN 755.2 / Minimum mechanical properties, according to European Standard EN 755.2

TIPI DI PROFILO TYPES OF PROFILE	Stato fisico di fornitura Temper state	Diametro D [mm] per tondi, o spess. S [mm] per barre, o di parete e per profili Diameter D [mm] for rods or thickness TH [mm] for bars or thickness of walls and for sections		Carico di rottura a trazione R _m [MPa]		Carico limite di elasticità R _{p0.2} [MPa]		Allungamento Elongation	
		min	max	min	max	A % min	A _{50mm} % min		
BARRI PIENE FULL BARS	T6	D ≤ 25	S ≤ 25	270	-	225	-	10	8
		25 ≤ D ≤ 50	25 ≤ S ≤ 50	270	-	225	-	8	-
		50 ≤ D ≤ 100	50 ≤ S ≤ 100	260	-	215	-	8	-
TUBI	T6	e ≤ 5		270	-	225	-	8	6
		5 < e ≤ 10		260	-	215	-	8	6
PROFILI APERTI SECTIONS	T4	e ≤ 25		180	-	90	-	15	13
		e ≤ 5		270	-	225	-	8	6
	T6	5 < e ≤ 10		260	-	215	-	8	6
		10 < e ≤ 25		250	-	200	-	8	6
PROFILI CAVI	T6	e ≤ 10		180	-	90	-	15	13
		e ≤ 5 5 < e ≤ 15		255 250	-	215 200	-	8 8	6 6

EN AW-6063

LEGA DI ALLUMINIO DA ESTRUSIONE / EXTRUSION ALUMINIUM ALLOY

I manufatti estrusi in lega d'alluminio EN AW 6063 trovano impiego in condizioni ambientali di corrosione accentuata, ove peraltro la resistenza meccanica costituisce requisito irrinunciabile, seppure con valori numerici medio-bassi, o per funzioni strutturali di livello secondario.

Extruded aluminium products - alloy EN AW 6063 are used in environmental conditions of severe corrosion, where mechanical strength is a prerequisite, albeit with low to medium numerical values, or for secondary level structural functions.

Caratteristiche fisiche / Physical characteristics

Massa volumica / Volume mass	2,71 g / cm ³	
Punto di fusione inferiore / Lower melting point	600 °C	
Calore specifico tra 0° e 100°C / Specific heat between 0° and 100°C	897 J / Kg °K	
Modulo di elasticità lineare E / Linear modulus of elasticity E	69000 N / mm ²	
Modulo elasticità tangenziale G / Tangential modulus of elasticity G	26000 N / mm ²	
Conducibilità termica a 20°C Thermal conductivity at 20°C	Nello stato O / In state O	2,09 W / cm °K
	Nello stato T6 / In state T6	1,72 W / cm °K
Coefficiente di dilatazione termica lineare Linear thermal expansion coefficient	Tra 20° e 100°C / 20° - 100°C	23,2 · 10 ⁻⁶ 1 / °K
	Tra 20° e 200°C / 20° - 200°C	24,1 · 10 ⁻⁶ 1 / °K
	Tra 20° e 300°C / 20° - 300°C	25,0 · 10 ⁻⁶ 1 / °K
Resistività elettrica a 20°C Electrical resistivity at 20°C	Nello stato O / In state O	3,14 μΩ · cm
	Nello stato T6 / In state T6	3,85 μΩ · cm

Composizione chimica secondo Norma Europea EN 573.3 / Chemical composition according to European Standard EN 573.3

	Si	Fe	Cu	Mn	Mg	Cr	Zn	Ti	ALTRI / OTHERS		Al
									Ciascuno Each	Totale Total	
EN AW - 6063	0,20 ± 0,60	0,35 max	0,10 max	0,10 max	0,45 ± 0,90	0,10 max	0,10 max	0,10 max	0,05 max	0,15 max	resto

Proprietà meccaniche minime, secondo Norma Europea EN 755.2 / Minimum mechanical properties, according to European Standard EN 755.2

TIPI DI PROFILO TYPES OF PROFILE	Stato fisico di fornitura Temper state	Diametro D [mm] per tondi, o spess. S [mm] per barre, o spess. di parete e per profili Diameter D [mm] for rods or thickness TH [mm] for bars or thickness of walls and for sections	Carico di rottura a trazione Rm [MPa] Tensile strength Rm [MPa]		Carico limite di elasticità R _{p0.2} [MPa] Limit elasticity load R _{p0.2} [MPa]		Allungamento Elongation	
			min	max	min	max	A % min	A _{50mm} % min
			TONDI E BARRE PIENE / ROUND TUBES AND FULL BARS	O, H111	D ≤ 200 D ≤ 150 150 ≤ D ≤ 200	S ≤ 200 S ≤ 150 150 ≤ S ≤ 200	- 130 120	130 -
TUBO ESTRUSO / EXTRUDED PIPE	T5	D ≤ 200	S ≤ 200	175	130	130	8	6
	T6 (*)	D ≤ 150 150 ≤ D ≤ 200	S ≤ 150 150 ≤ S ≤ 200	215 195	-	170 160	-	10 10
	T66 (*)	D ≤ 200	S ≤ 200	245	-	200	-	10
	T4 (*)	e ≤ 25		130	-	65	-	14
	T5	e ≤ 10 10 ≤ e ≤ 25		175 160		130 110		8 7
PROFILATI / PROFILES	T6 (*)	e ≤ 10 10 ≤ e ≤ 25		215 195	-	170 160	-	8 8
	T64 (*)	e ≤ 15		180		120		12
	T66 (*)	e ≤ 10 10 ≤ e ≤ 25		245 225		200 180		8 8

a step further

a step further



Takler Srl

Headquarters

Via Alberto Manicone
Zona Industriale Jesce

75100 Matera | Italy

+39 0835 251911

info@taklergroup.com

Member of CISQ Automotive



Associato a
CONFINDUSTRIA
Basilicata



Associato a
CONFINDUSTRIA
Bari e Barletta-Andria-Trani

taklergroup.com

[in](#) [f](#) [@](#) [▶](#)